

STATE OF NORTH CAROLINA
DEPARTMENT OF TRANSPORTATION
HIGHWAY DIVISION 4

PROPOSAL

DATE AND TIME OF BID OPENING: January 27, 2026 AT 2:00 PM

CONTRACT ID: DD00503

WBS ELEMENT NO.: 2026CPT.04.08.10981

FEDERAL AID NO.: STATE FUNDED

COUNTY: WILSON COUNTY

TIP NO.: N/A

MILES: 13.17

ROUTE NO.: NC-581

LOCATION: 2 SECTIONS OF PRIMARY ROUTE ON NC-581

★ **TYPE OF WORK:** MILLING AND RESURFACING ★

NOTICE:

ALL BIDDERS SHALL COMPLY WITH ALL APPLICABLE LAWS REGULATING THE PRACTICE OF GENERAL CONTRACTING AS CONTAINED IN CHAPTER 87 OF THE GENERAL STATUTES OF NORTH CAROLINA WHICH REQUIRES THE BIDDER TO BE LICENSED BY THE N.C. LICENSING BOARD FOR CONTRACTORS WHEN BIDDING ON ANY NON-FEDERAL AID PROJECT WHERE THE BID IS \$30,000 OR MORE, EXCEPT FOR CERTAIN SPECIALTY WORK AS DETERMINED BY THE LICENSING BOARD. BIDDERS SHALL ALSO COMPLY WITH ALL OTHER APPLICABLE LAWS REGULATING THE PRACTICES OF ELECTRICAL, PLUMBING, HEATING AND AIR CONDITIONING AND REFRIGERATION CONTRACTING AS CONTAINED IN CHAPTER 87 OF THE GENERAL STATUTES OF NORTH CAROLINA. NOTWITHSTANDING THESE LIMITATIONS ON BIDDING, THE BIDDER WHO IS AWARDED ANY FEDERAL - AID FUNDED PROJECT SHALL COMPLY WITH CHAPTER 87 OF THE GENERAL STATUTES OF NORTH CAROLINA FOR LICENSING REQUIREMENTS WITHIN 60 CALENDAR DAYS OF BID OPENING.

THIS IS A ROADWAY PROJECT.

BID BOND IS REQUIRED.

NAME OF BIDDER

ADDRESS OF BIDDER

**PROPOSAL FOR THE CONSTRUCTION OF
CONTRACT No. DD00503 IN WILSON COUNTY, NORTH CAROLINA
DEPARTMENT OF TRANSPORTATION,
WILSON, NORTH CAROLINA**

The Bidder has carefully examined the location of the proposed work to be known as Contract No. **DD00503**; has carefully examined the plans and specifications, which are acknowledged to be part of the proposal, the special provisions, the proposal, the form of contract, and the forms of contract payment bond and contract performance bond; and thoroughly understands the stipulations, requirements and provisions. The undersigned bidder agrees to bound upon his execution of the bid and subsequent award to him by the Department of Transportation in accordance with this proposal to provide the necessary contract payment bond and contract performance bond within fourteen days after the written notice of award is received by him. The undersigned Bidder further agrees to provide all necessary machinery, tools, labor, and other means of construction; and to do all the work and to furnish all materials, except as otherwise noted, necessary to perform and complete the said contract in accordance with the *2024 Standard Specifications for Roads and Structures* by the dates(s) specified in the Project Special Provisions and in accordance with the requirements of the Engineer, and at the unit or lump sum prices, as the case may be, for the various items given on the sheets contained herein.

The Bidder shall provide and furnish all the materials, machinery, implements, appliances and tools, and perform the work and required labor to construct and complete Contract No. **DD00503** in **Wilson County**, for the unit or lump sum prices, as the case may be, bid by the Bidder in his bid and according to the proposal, plans, and specifications prepared by said Department, which proposal, plans, and specifications show the details covering this project, and hereby become a part of this contract.

The published volume entitled *North Carolina Department of Transportation, Raleigh, Standard Specifications for Roads and Structures, January 2024* with all amendments and supplements thereto, is by reference incorporated into and made a part of this contract; that, except as herein modified, all the construction and work included in this contract is to be done in accordance with the specifications contained in said volume, and amendments and supplements thereto, under the direction of the Engineer.

If the proposal is accepted and the award is made, the contract is valid only when signed either by the Contract Officer or such other person as may be designated by the Secretary to sign for the Department of Transportation. The conditions and provisions herein cannot be changed except over the signature of the said Contract Officer or Division Engineer.

The quantities shown in the itemized proposal for the project are considered to be approximate only and are given as the basis for comparison of bids. The Department of Transportation may increase or decrease the quantity of any item or portion of the work as may be deemed necessary or expedient.

An increase or decrease in the quantity of an item will not be regarded as sufficient ground for an increase or decrease in the unit prices, nor in the time allowed for the completion of the work, except as provided for the contract.

Accompanying this bid is a bid bond secured by a corporate surety, or certified check payable to the order of the Department of Transportation, for five percent of the total bid price, which deposit is to be forfeited as liquidated damages in case this bid is accepted and the Bidder shall fail to provide the required payment and performance bonds with the Department of Transportation, under the condition of this proposal, within 14 calendar days after the written notice of award is received by him, as provided in the *Standard Specifications*; otherwise said deposit will be returned to the Bidder.

TABLE OF CONTENTS

**COVER SHEET
PROPOSAL SHEET**

PROJECT SPECIAL PROVISIONS

BOND REQUIREMENTS: G-1
CONTRACT TIME AND LIQUIDATED DAMAGES: G-1
INTERMEDIATE CONTRACT TIME NUMBER 1 AND LIQUIDATED DAMAGES: G-1
INTERMEDIATE CONTRACT TIME NUMBER 2 AND LIQUIDATED DAMAGES: G-2
PROSECUTION OF WORK:..... G-3
RAILROAD GRADE CROSSING: G-3
NO MAJOR CONTRACT ITEMS: G-5
NO SPECIALTY ITEMS: G-6
FUEL PRICE ADJUSTMENT:..... G-6
MINORITY BUSINESS ENTERPRISE AND WOMEN BUSINESS ENTERPRISE
(DIVISIONS):..... G-7
RESTRICTIONS ON ITS EQUIPMENT AND SERVICES:..... G-22
USE OF UNMANNED AIRCRAFT SYSTEM (UAS): G-22
EQUIPMENT IDLING GUIDELINES:..... G-23
OUTSOURCING OUTSIDE THE USA: G-23

ROADWAYR-1
IMP, SUMMARY OF QUANTITIES, TYPICALS, MAPS & DETAILSR-20

UNIT PROJECT SPECIAL PROVISIONS

TRAFFIC CONTROL TC-1

STANDARD SPECIAL PROVISIONS

AVAILABILITY OF FUNDS – TERMINATION OF CONTRACTSSSP-1
ERRATA.....SSP-2
PLANT AND PEST QUARANTINESSSP-5
MINIMUM WAGESSSP-6
TITLE VI AND NONDISCRIMINATION:SSP-7
ON-THE-JOB TRAINING.....SSP-16

PROPOSAL ITEM SHEET AND DOT SIGNATURE SHEET

INSTRUCTIONS TO BIDDERS**PLEASE READ ALL INSTRUCTIONS CAREFULLY
BEFORE PREPARING AND SUBMITTING YOUR BID.**

All bids shall be prepared and submitted in accordance with the following requirements. Failure to comply with any requirement may cause the bid to be considered irregular and may be grounds for rejection of the bid.

For preparing and submitting the bid electronically, refer to Article 102-8(B) of the *Standard Specifications*.

Bidders that bid electronically on Raleigh Central-Let projects will need a separate Digital Signature from the approved electronic bidding provider for Division Contracts.

ELECTRONIC ON-LINE BID:

1. Download entire proposal from Connect NCDOT website. Download the electronic submittal file from the approved electronic bidding provider website.
2. In accordance with Article 102-3 of the Standard Specifications, registration on the Interested Parties List is required unless SP1 G02 Interested Parties List Not Required provision is included in the proposal.
3. Prepare and submit the electronic submittal file using the approved electronic bidding provider software.
4. Electronic bidding software necessary for electronic bid preparation may be downloaded from the Bid Express website following the directions at: <https://connect.ncdot.gov/letting/Pages/Electronic-Bidding.aspx>.
5. Questions should be emailed 7 calendar days prior to the bid opening to **Vickie P. Gardner** at **vpgardner@ncdot.gov**. Contact with any other NCDOT personnel concerning this project is strictly prohibited, unless otherwise noted, and may result in bids being considered non-responsive.

PROJECT SPECIAL PROVISIONS**GENERAL****BOND REQUIREMENTS:**

(6-1-16)(Rev.1-16-24)

102-8, 102-10

SPD 01-420A

A Bid Bond is required in accordance with Article 102-10 of the *Standard Specifications for Roads and Structures*.

Contract Payment and Performance Bonds are required in accordance with Article 103-7 of the *Standard Specifications*.

CONTRACT TIME AND LIQUIDATED DAMAGES:

(7-1-95) (Rev. 12-18-07)

108

SP1 G10 A

The date of availability for this contract is **March 2, 2026**.

The completion date for this contract is **September 3, 2027**.

Except where otherwise provided by the contract, observation periods required by the contract will not be a part of the work to be completed by the completion date and/or intermediate contract times stated in the contract. The acceptable completion of the observation periods that extend beyond the final completion date shall be a part of the work covered by the performance and payment bonds.

The liquidated damages for this contract are **One Thousand Six Hundred Dollars (\$1,600.00)** per calendar day.

INTERMEDIATE CONTRACT TIME NUMBER 1 AND LIQUIDATED DAMAGES:

Except for final/long life pavement markings, the Contractor will be required to complete all work included in this contract and shall place and maintain traffic on same.

The date of availability for this intermediate contract time is **March 2, 2026**.

The completion date for this intermediate contract time is **August 6, 2027**.

The liquidated damages are **One Thousand Six Hundred Dollars (\$1,600.00)** per calendar day.

INTERMEDIATE CONTRACT TIME NUMBER 2 AND LIQUIDATED DAMAGES:

(2-20-07)

108

SP1 G14 A

The Contractor shall complete the required work of installing, maintaining, and removing the traffic control devices for lane closures and restoring traffic to the existing traffic pattern. The Contractor shall not close or narrow a lane of traffic on **Any Maps** during the following time restrictions:

DAY AND TIME RESTRICTIONS

All Maps

Monday thru Sunday 9:00PM to 6:00AM

In addition, the Contractor shall not close or narrow a lane of traffic on **Any Map**, detain and/or alter the traffic flow on or during holidays, holiday weekends, special events, or any other time when traffic is unusually heavy, including the following schedules:

HOLIDAY AND HOLIDAY WEEKEND LANE CLOSURE RESTRICTIONS

1. For **unexpected occurrence** that creates unusually high traffic volumes, as directed by the Engineer.
2. For **New Year's Day**, between the hours of **6:00am** December 31st and **7:00pm** January 2nd. If New Year's Day is on a Friday, Saturday, Sunday or Monday, then until **7:00pm** the following Tuesday.
3. For **Easter**, between the hours of **6:00am** Thursday and **7:00pm** Monday.
4. For **Memorial Day**, between the hours of **6:00am** Friday and **7:00pm** Tuesday.
5. For **Independence Day**, between the hours of **6:00 a.m.** the day before Independence Day and **7:00 p.m.** the day after Independence Day.

If **Independence Day** is on a Friday, Saturday, Sunday or Monday, then between the hours of **6:00 a.m.** the Thursday before Independence Day and **7:00 p.m.** the Tuesday after Independence Day.
6. For **Labor Day**, between the hours of **6:00am** Friday and **7:00pm** Tuesday.
7. For **Thanksgiving Day**, between the hours of **6:00am** Tuesday and **7:00pm** Monday.
8. For **Christmas**, between the hours of **6:00am** the Friday before the week of Christmas Day and **7:00pm** the following Tuesday after the week of Christmas Day.

Holidays and holiday weekends shall include New Year's, Easter, Memorial Day, Independence Day, Labor Day, Thanksgiving, and Christmas. The Contractor shall schedule his work so that lane closures will not be required during these periods, unless otherwise directed by the Engineer.

The time of availability for this intermediate contract work shall be the time the Contractor begins to install all traffic control devices for lane closures according to the time restrictions listed herein.

The completion time for this intermediate contract work shall be the time the Contractor is required to complete the removal of all traffic control devices for lane closures according to the time restrictions stated above and place traffic in the existing traffic pattern.

The liquidated damages are **One Thousand Dollars (\$1,000.00)** per hour.

PROSECUTION OF WORK:

(7-1-95) (Rev. 8-21-12)

108

SP1 G15R

The Contractor will be required to prosecute the work in a continuous and uninterrupted manner from the time he begins the work until completion and final acceptance of the project. The Contractor will not be permitted to suspend his operations except for reasons beyond his control or except where the Engineer has authorized a suspension of the Contractor's operations in writing.

In the event that the Contractor's operations are suspended in violation of the above provisions, the sum of **\$500.00** will be charged the Contractor for each and every calendar day that such suspension takes place. The said amount is hereby agreed upon as liquidated damages due to extra engineering and maintenance costs and due to increased public hazard resulting from a suspension of the work. Liquidated damages chargeable due to suspension of the work will be additional to any liquidated damages that may become chargeable due to failure to complete the work on time.

RIGHT OF ENTRY TO CSX TRANSPORTATION RIGHT-OF-WAY:

The contractor shall contact the NCDOT Rail Division to begin the Right of Entry (ROE) process. The ROE requirements shall include, but are not limited to, providing necessary insurance, dates work will be performed and any applicable fees. The contractor shall obtain this ROE agreement from CSXT prior to performing any construction activities within the Railroad Right of Way.

The contractor shall allow at least 120 days for the approval of the Right of Entry.

For assistance, contact the Resident Engineer or the Surfaces and Encroachment manager with the Rail Division of NCDOT at mmclamb@ncdot.gov.

All costs associated with satisfying CSX requirements and obtaining the ROE agreement, including, but not limited to, ROE fees and insurance shall be included in the price bid for the pay items associated with the work inside the railroad right of way. No separate measurement or payment will be made for these costs.

Once work begins within the Railroad Right-of-Way, complete all operations in the Railroad Right of Way in a continuous manner in order to minimize CSXT flagging resources.

CSXT Insurance Requirements**I. Insurance Policies:**

Agency and Contractor, if and to the extent that either is performing work on or about CSXT's property, shall procure and maintain the following insurance policies:

1. Commercial General Liability coverage at their sole cost and expense with limits of not less than \$5,000,000 in combined single limits for bodily injury and/or property damage per occurrence, and such policies shall name CSXT as an additional named insured. The policy shall include endorsement ISO CG 24 17 evidencing that coverage is provided for work within 50 feet of a railroad. If such endorsement is not included, railroad protective liability insurance must be provided as described in item 4 below.
2. Statutory Worker's Compensation and Employers Liability Insurance with limits of not less than \$1,000,000.00, which insurance must contain a waiver of subrogation against CSXT and its affiliates (if permitted by state law).
3. Commercial automobile liability insurance with limits of not less than \$1,000,000.00 combined single limit for bodily injury and/or property damage per occurrence, and such policies shall name CSXT as an additional named insured. The policy shall include endorsement ISO CA 20 70 evidencing that coverage is provided for work within 50 feet of a railroad. If such endorsement is not included, railroad protective liability insurance must be provided as described in item 4 below.
4. Railroad protective liability insurance with limits of not less than \$5,000,000.00 combined single limit for bodily injury and/or property damage per occurrence and an aggregate annual limit of \$10,000,000.00, which insurance shall satisfy the following additional requirements:
 - a. The Railroad Protective Insurance Policy must be on the ISO/RIMA Form of Railroad Protective Insurance - Insurance Services Office (ISO) Form CG 00 35.
 - b. CSX Transportation must be the named insured on the Railroad Protective Insurance Policy.
 - c. Name and Address of Contractor and Agency must appear on the Declarations page.
 - d. Description of operations must appear on the Declarations page and must match the Project description.
 - e. Authorized endorsements must include the Pollution Exclusion Amendment - CG 28 31, unless using form CG 00 35 version 96 and later.

- f. Authorized endorsements may include:
 - (i). Broad Form Nuclear Exclusion - IL 00 21
 - (ii) 30-day Advance Notice of Non-renewal or cancellation
 - (iii) Required State Cancellation Endorsement
 - (iv) Quick Reference or Index - CL/IL 240
 - g. Authorized endorsements may not include:
 - (i) A Pollution Exclusion Endorsement except CG 28 31
 - (ii) A Punitive or Exemplary Damages Exclusion
 - (iii) A "Common Policy Conditions" Endorsement
 - (iv) Any endorsement that is not named in Section 4 (e) or (f) above.
 - (v) Policies that contain any type of deductible
5. All insurance companies must be A. M. Best rated A- and Class VII or better.
 6. The CSX OP number or CSX contract number, as applicable, must appear on each Declarations page and/or certificates of insurance.
 7. Such additional or different insurance as CSXT may require.

II. Additional Terms

1. Contractor must submit the original Railroad Protective Liability policy, Certificates of Insurance and all notices and correspondence regarding the insurance policies to:

Insurance Department
 CSX Transportation,
 Inc. 500 Water Street,
 C-907 Jacksonville, FL
 32202

OR

insurancedocuments@csx.com and mmclamb@ncdot.gov

2. Neither Agency nor Contractor may begin work on the Project until it has received CSXT's written approval of the required insurance.

NO MAJOR CONTRACT ITEMS:

(2-19-02) (Rev. 8-21-07)

104

SP1 G31

None of the items included in this contract will be major items.

NO SPECIALTY ITEMS:

(7-1-95)(Rev. 1-16-24)

108-6

SP1 G34

None of the items included in this contract will be specialty items (see Article 108-6 of the *Standard Specifications*).

FUEL PRICE ADJUSTMENT:

(11-15-05)(Rev. 1-16-24)

109-8

SP1 G43

Page 1-82, Article 109-8, FUEL PRICE ADJUSTMENTS, add the following:

The base index price for DIESEL #2 FUEL is **\$2.6947** per gallon. Where any of the following are included as pay items in the contract, they will be eligible for fuel price adjustment.

The pay items and the fuel factor used in calculating adjustments to be made will be as follows:

Description	Units	Fuel Usage Factor Diesel
Unclassified Excavation	Gal/CY	0.29
Borrow Excavation	Gal/CY	0.29
Class IV Subgrade Stabilization	Gal/Ton	0.55
Aggregate Base Course	Gal/Ton	0.55
Sub-Ballast	Gal/Ton	0.55
Erosion Control Stone	Gal/Ton	0.55
Rip Rap, Class _____	Gal/Ton	0.55
Asphalt Concrete Base Course, Type _____	Gal/Ton	0.90 or 2.90
Asphalt Concrete Intermediate Course, Type _____	Gal/Ton	0.90 or 2.90
Asphalt Concrete Surface Course, Type _____	Gal/Ton	0.90 or 2.90
Open-Graded Asphalt Friction Course	Gal/Ton	0.90 or 2.90
Permeable Asphalt Drainage Course, Type _____	Gal/Ton	0.90 or 2.90
Sand Asphalt Surface Course, Type _____	Gal/Ton	0.90 or 2.90
Ultra-thin Bonded Wearing Course	Gal/Ton	0.90 or 2.90
Aggregate for Cement Treated Base Course	Gal/Ton	0.55
Portland Cement for Cement Treated Base Course	Gal/Ton	0.55
> 11" Portland Cement Concrete Pavement	Gal/SY	0.327
Concrete Shoulders Adjacent to > 11" Pavement	Gal/SY	0.327
9" to 11" Portland Cement Concrete Pavement	Gal/SY	0.272
Concrete Shoulders Adjacent to 9" to 11" Pavement	Gal/SY	0.272
< 9" Portland Cement Concrete Pavement	Gal/SY	0.245
Concrete Shoulders Adjacent to < 9" Pavement	Gal/SY	0.245

For the asphalt items noted in the chart as eligible for fuel adjustments, the bidder may include the *Fuel Usage Factor Adjustment Form* with their bid submission if they elect to use the fuel usage factor. The *Fuel Usage Factor Adjustment Form* is found at the following link:

<https://connect.ncdot.gov/letting/LetCentral/Fuel%20Usage%20Factor%20Adjustment%20Form%20-%20Starting%20Nov%202022%20Lettings.pdf>

Select either 2.90 Gal/Ton fuel factor or 0.90 Gal/Ton fuel factor for each asphalt line item on the *Fuel Usage Factor Adjustment Form*. The selected fuel factor for each asphalt item will remain in effect for the duration of the contract.

Failure to complete the *Fuel Usage Factor Adjustment Form* will result in using 2.90 gallons per ton as the Fuel Usage Factor for Diesel for the asphalt items noted above. The contractor will not be permitted to change the Fuel Usage Factor after the bids are submitted.

MINORITY BUSINESS ENTERPRISE AND WOMEN BUSINESS ENTERPRISE (DIVISIONS):

(10-16-07)(Rev. 10-21-25)

102-15(J)

SP1 G67

Description

The purpose of this Special Provision is to carry out the North Carolina Department of Transportation's policy of ensuring nondiscrimination in the award and administration of contracts financed in whole or in part with State funds.

Definitions

Additional MBE/WBE Subcontractors - Any MBE/WBE submitted at the time of bid that will not be used to meet the Combined MBE/WBE goal. No submittal of a Letter of Intent is required.

Combined MBE/WBE Goal: A portion of the total contract, expressed as a percentage that is to be performed by committed MBE/WBE subcontractors.

Committed MBE/WBE Subcontractor - Any MBE/WBE submitted at the time of bid that is being used to meet the Combined MBE / WBE goal by submission of a Letter of Intent. Or any MBE or WBE used as a replacement for a previously committed MBE or WBE firm.

Contract Goal Requirement - The approved participation at time of award, but not greater than the advertised Combined MBE/WBE contract goal.

Goal Confirmation Letter - Written documentation from the Department to the bidder confirming the Contractor's approved, committed participation along with a listing of the committed MBE and WBE firms.

Manufacturer - A firm that owns (or leases) and operates or maintains a factory or establishment that produces on the premises, the materials or supplies obtained by the Contractor. A firm that makes minor modifications to the materials, supplies, articles, or equipment is not a manufacturer.

MBE Participation (Anticipated) - A portion of the total contract, expressed as a percentage that is anticipated to be performed by committed MBE subcontractor(s).

Minority Business Enterprise (MBE) - A firm certified as a Disadvantaged Minority-Owned Business Enterprise through the North Carolina Unified Certification Program.

Regular Dealer - A firm that owns (or leases), and operates a store, warehouse, or other establishment in which the materials or supplies required for the performance of the contract are bought, kept in sufficient quantities, and regularly sold to the public in the usual course of business. A regular dealer engages in, as its principal business and in its own name, the purchase and sale or lease of the products in question. A regular dealer in such bulk items as steel, concrete or concrete products, gravel, stone, asphalt and petroleum products need not keep such products in stock, if it owns and operates distribution equipment for the products. Any supplement of regular dealers' own distribution equipment shall be by a long-term operating lease and not on an ad hoc or contract-by-contract basis.

Distributor - A firm that engages in the regular sale or lease of the items specified by the contract. A distributor assumes responsibility for the items it purchases once they leave the point of origin (e.g., a manufacturer's facility), making it liable for any loss or damage not covered by the carrier's insurance.

Replacement / Substitution - A full or partial reduction in the amount of work subcontracted to a committed (or an approved substitute) MBE/WBE firm.

North Carolina Unified Certification Program (NCUCP) - A program that provides comprehensive services and information to applicants for MBE/WBE certification. The MBE/WBE program follows the same regulations as the federal Disadvantaged Business Enterprise (DBE) program in accordance with 49 CFR Part 26.

United States Department of Transportation (USDOT) - Federal agency responsible for issuing regulations (49 CFR Part 26) and official guidance for the DBE program.

WBE Participation (Anticipated) - A portion of the total contract, expressed as a percentage that is anticipated to be performed by committed WBE subcontractor(s).

Women Business Enterprise (WBE) - A firm certified as a Disadvantaged Women-Owned Business Enterprise through the North Carolina Unified Certification Program.

Forms and Websites Referenced in this Provision

Payment Tracking System - On-line system in which the Contractor enters the payments made to MBE and WBE subcontractors who have performed work on the project.
<https://apps.dot.state.nc.us/Vendor/PaymentTracking/>

DBE-IS Subcontractor Payment Information - Form for reporting the payments made to all MBE/WBE firms working on the project. This form is for paper bid projects only.
<https://connect.ncdot.gov/business/Turnpike/Documents/Form%20DBE-IS%20Subcontractor%20Payment%20Information.pdf>

RF-1 MBE/WBE Replacement Request Form - Form for replacing a committed MBE or WBE.
<https://connect.ncdot.gov/projects/construction/Construction%20Forms/DBE%20MBE%20WBE%20Replacement%20Form%20and%20Instructions.pdf>

SAF Subcontract Approval Form - Form required for approval to sublet the contract.

<https://connect.ncdot.gov/projects/construction/Construction%20Forms/SAF%20Form%20-%20Subcontract%20Approval%20Form%20Revised%2004-19.xlsm>

JC-1 Joint Check Notification Form - Form and procedures for joint check notification. The form acts as a written joint check agreement among the parties providing full and prompt disclosure of the expected use of joint checks.

<http://connect.ncdot.gov/projects/construction/Construction%20Forms/Joint%20Check%20Notification%20Form.pdf>

Letter of Intent - Form signed by the Contractor and the MBE/WBE subcontractor, manufacturer or regular dealer that affirms that a portion of said contract is going to be performed by the signed MBE/WBE for the estimated amount (based on quantities and unit prices) listed at the time of bid.

<http://connect.ncdot.gov/letting/LetCentral/Letter%20of%20Intent%20to%20Perform%20as%20a%20Subcontractor.pdf>

Listing of MBE and WBE Subcontractors Form - Form for entering MBE/WBE subcontractors on a project that will meet the Combined MBE/WBE goal. This form is for paper bids only.

[http://connect.ncdot.gov/municipalities/Bid%20Proposals%20for%20LGA%20Content/09%20MBE-WBE%20Subcontractors%20\(State\).docx](http://connect.ncdot.gov/municipalities/Bid%20Proposals%20for%20LGA%20Content/09%20MBE-WBE%20Subcontractors%20(State).docx)

Subcontractor Quote Comparison Sheet - Spreadsheet for showing all subcontractor quotes in the work areas where MBEs and WBEs quoted on the project. This sheet is submitted with good faith effort packages.

<http://connect.ncdot.gov/business/SmallBusiness/Documents/DBE%20Subcontractor%20Quote%20Comparison%20Example.xls>

DBE Regular Dealer/Distributor Affirmation Form – Form is used to make a preliminary counting determination for each DBE listed as a regular dealer or distributor to assess its eligibility for 60 or 40 percent credit, respectively of the cost of materials or supplies based on its demonstrated capacity and intent to perform as a regular dealer or distributor, as defined in section 49 CFR 26.55 under the contract at issue. A Contractor will submit the completed form with the Letter of Intent.

<https://connect.ncdot.gov/projects/construction/Construction%20Forms/DBE%20Regular%20Dealer-Distributor%20Affirmation%20Form%20-%20USDOT%202024.pdf>

Combined MBE/WBE Goal

There is NO MBE/WBE Goal for this project.

Directory of Transportation Firms (Directory)

Real-time information is available about firms doing business with the Department and firms that are certified through NCUCP in the Directory of Transportation Firms. Only firms identified in the Directory as MBE and WBE certified shall be used to meet the Combined MBE / WBE goal. The Directory can be found at the following link.

<https://www.ebs.nc.gov/VendorDirectory/default.html>

The listing of an individual firm in the directory shall not be construed as an endorsement of the firm's capability to perform certain work.

Listing of MBE/WBE Subcontractors

At the time of bid, bidders shall submit all MBE and WBE participation that they anticipate to use during the life of the contract. Only those identified to meet the Combined MBE/WBE goal will be considered committed, even though the listing shall include both committed MBE/WBE subcontractors and additional MBE/WBE subcontractors. Any additional MBE/WBE subcontractor participation above the goal will follow the banking guidelines found elsewhere in this provision. All other additional MBE/WBE subcontractor participation submitted at the time of bid will be used toward the Department's overall race-neutral goals. Only those firms with current MBE and WBE certification at the time of bid opening will be acceptable for listing in the bidder's submittal of MBE and WBE participation. The Contractor shall indicate the following required information:

(A) Electronic Bids

Bidders shall submit a listing of MBE and WBE participation in the appropriate section of the electronic submittal file.

- (1) Submit the names and addresses of MBE and WBE firms identified to participate in the contract. If the bidder uses the updated listing of MBE and WBE firms shown in the electronic submittal file, the bidder may use the dropdown menu to access the name and address of the firms.
- (2) Submit the contract line numbers of work to be performed by each MBE and WBE firm. When no figures or firms are entered, the bidder will be considered to have no MBE or WBE participation.
- (3) The bidder shall be responsible for ensuring that the MBE and WBE are certified at the time of bid by checking the Directory of Transportation Firms. If the firm is not certified at the time of the bid-letting, that MBE's or WBE's participation will not count towards achieving the Combined MBE/WBE goal.

(B) Paper Bids

- (1) *If the Combined MBE/ WBE goal is more than zero,*
 - (a) Bidders, at the time the bid proposal is submitted, shall submit a listing of MBE/WBE participation, including the names and addresses on *Listing of MBE and WBE Subcontractors* contained elsewhere in the contract documents in order for the bid to be considered responsive. Bidders shall indicate the total dollar value of the MBE and WBE participation for the contract.
 - (b) If bidders have no MBE or WBE participation, they shall indicate this on the *Listing of MBE and WBE Subcontractors* by entering the word "None"

or the number "0." This form shall be completed in its entirety. **Blank forms will not be deemed to represent zero participation.** Bids submitted that do not have MBE and WBE participation indicated on the appropriate form will not be read publicly during the opening of bids. The Department will not consider these bids for award and the proposal will be rejected.

- (c) The bidder shall be responsible for ensuring that the MBE/WBE is certified at the time of bid by checking the Directory of Transportation Firms. If the firm is not certified at the time of the bid-letting, that MBE's or WBE's participation will not count towards achieving the Combined MBE/WBE goal.
- (2) *If the Combined MBE/WBE Goal is zero, entries on the Listing of MBE and WBE Subcontractors are not required for the zero goal, however any MBE or WBE participation that is achieved during the project shall be reported in accordance with requirements contained elsewhere in the special provision.*

MBE or WBE Prime Contractor

When a certified MBE or WBE firm bids on a contract that contains a Combined MBE/WBE Goal, the firm is responsible for meeting the goal or making good faith efforts to meet the goal, just like any other bidder. In most cases, a MBE or WBE bidder on a contract will meet the Combined MBE/WBE goal by virtue of the work it performs on the contract with its own forces. However, all the work that is performed by the MBE or WBE bidder and any other similarly certified subcontractors will count toward the goal. The MBE or WBE bidder shall list itself along with any MBE or WBE subcontractors, if any, in order to receive credit toward the goals.

MBE/WBE prime contractors shall also follow Sections A or B listed under *Listing of MBE/WBE Subcontractors* just as a non-MBE/WBE bidder would.

Written Documentation – Letter of Intent

The bidder shall submit written documentation for each MBE/WBE that will be used to meet the Combined MBE/WBE goal of the contract, indicating the bidder's commitment to use the MBE/WBE in the contract. This documentation shall be submitted on the Department's form titled *Letter of Intent*.

The documentation shall be received in the office of the Engineer no later than 2:00 p.m. of the fifth calendar day following opening of bids, unless the fifth day falls on Saturday, Sunday or an official state holiday. In that situation, it is due in the office of the Engineer no later than 10:00 a.m. on the next official state business day.

If the bidder fails to submit the Letter of Intent from each committed MBE and WBE to be used toward the Combined MBE/WBE goal, or if the form is incomplete (i.e. both signatures are not present), the MBE/WBE participation will not count toward meeting the Combined MBE/WBE goal. If the lack of this participation drops the commitment below the Combined MBE/WBE goal, the Contractor shall submit evidence of good faith efforts for the goal not met, completed in

its entirety, to the Engineer no later than 2:00 p.m. of the eighth calendar day following opening of bids, unless the eighth day falls on Saturday, Sunday or an official state holiday. In that situation, it is due in the office of the Engineer no later than 10:00 a.m. on the next official state business day.

Banking MBE/WBE Credit

If the committed MBE/WBE participation submitted exceeds the algebraic sum of the Combined MBE/WBE goal by \$1,000 or more, the excess will be placed on deposit by the Department for future use by the bidder. Separate accounts will be maintained for MBE and WBE participation and these may accumulate for a period not to exceed 24 months.

When the apparent lowest responsive bidder fails to submit sufficient participation by MBE and WBE firms to meet the advertised goal, as part of the good faith effort, the Department will consider allowing the bidder to withdraw funds to meet the Combined MBE/WBE goal as long as there are adequate funds available from the bidder's MBE and WBE bank accounts.

Submission of Good Faith Effort

If the bidder fails to meet or exceed the Combined MBE/WBE goal, the apparent lowest responsive bidder shall submit to the Department documentation of adequate good faith efforts made to reach that specific goal.

One complete set and one electronic copy (**in.PDF format**) of this information shall be received in the office of the Engineer no later than 2:00 p.m. of the fifth calendar day following opening of bids, unless the fifth day falls on Saturday, Sunday or an official state holiday. In that situation, it is due in the office of the Engineer no later than 10:00 a.m. on the next official state business day.

Note: Where the information submitted includes repetitious solicitation letters, it will be acceptable to submit a representative letter along with a distribution list of the firms that were solicited. Documentation of MBE/WBE quotations shall be a part of the good faith effort submittal. This documentation may include written subcontractor quotations, telephone log notations of verbal quotations, or other types of quotation documentation.

Consideration of Good Faith Effort for Projects with a Combined MBE/WBE Goal More Than Zero

Adequate good faith efforts mean that the bidder took all necessary and reasonable steps to achieve the goal which, by their scope, intensity, and appropriateness, could reasonably be expected to obtain sufficient MBE/WBE participation. Adequate good faith efforts also mean that the bidder actively and aggressively sought MBE/WBE participation. Mere *pro forma* efforts are not considered good faith efforts.

The Department will consider the quality, quantity, and intensity of the different kinds of efforts a bidder has made. Listed below are examples of the types of actions a bidder will take in making a good faith effort to meet the goals and are not intended to be exclusive or exhaustive, nor is it intended to be a mandatory checklist.

- (A) Soliciting through all reasonable and available means (e.g. attendance at pre-bid meetings, advertising, written notices, use of verifiable electronic means through the use of the NCDOT Directory of Transportation Firms) the interest of all certified MBEs/WBEs that are also prequalified subcontractors. The bidder must solicit this interest within at least 10 days prior to bid opening to allow the MBEs/WBEs to respond to the solicitation. Solicitation shall provide the opportunity to MBEs/WBEs within the Division and surrounding Divisions where the project is located. The bidder must determine with certainty if the MBEs/WBEs are interested by taking appropriate steps to follow up initial solicitations.
- (B) Selecting portions of the work to be performed by MBEs/WBEs in order to increase the likelihood that the Combined MBE/WBE goal will be achieved.
 - (1) Where appropriate, break out contract work items into economically feasible units to facilitate MBE/WBE participation, even when the prime contractor might otherwise prefer to perform these work items with its own forces.
 - (2) Negotiate with subcontractors to assume part of the responsibility to meet the advertised goal when the work to be sublet includes potential for MBE/WBE participation (2nd and 3rd tier subcontractors).
- (C) Providing interested certified MBEs/WBEs that are also prequalified subcontractors with adequate information about the plans, specifications, and requirements of the contract in a timely manner to assist them in responding to a solicitation.
- (D)
 - (1) Negotiating in good faith with interested MBEs/WBEs. It is the bidder's responsibility to make a portion of the work available to MBE/WBE subcontractors and suppliers and to select those portions of the work or material needs consistent with the available MBE/WBE subcontractors and suppliers, so as to facilitate MBE/WBE participation. Evidence of such negotiation includes the names, addresses, and telephone numbers of MBEs/WBEs that were considered; a description of the information provided regarding the plans and specifications for the work selected for subcontracting; and evidence as to why additional agreements could not be reached for MBEs/WBEs to perform the work.
 - (2) A bidder using good business judgment would consider a number of factors in negotiating with subcontractors, including MBE/WBE subcontractors, and would take a firm's price and capabilities as well as the advertised goal into consideration. However, the fact that there may be some additional costs involved in finding and using MBEs/WBEs is not in itself sufficient reason for a bidder's failure to meet the advertised goal, as long as such costs are reasonable. Also, the ability or desire of a prime contractor to perform the work of a contract with its own organization does not relieve the bidder of the responsibility to make

good faith efforts. Bidding contractors are not, however, required to accept higher quotes from MBEs/WBEs if the price difference is excessive or unreasonable.

- (E) Not rejecting MBEs/WBEs as being unqualified without sound reasons based on a thorough investigation of their capabilities. The bidder's standing within its industry, membership in specific groups, organizations, or associates and political or social affiliations (for example, union vs. non-union employee status) are not legitimate causes for the rejection or non-solicitation of bids in the bidder's efforts to meet the project goal.
- (F) Making efforts to assist interested MBEs/WBEs in obtaining bonding, lines of credit, or insurance as required by the recipient or bidder.
- (G) Making efforts to assist interested MBEs/WBEs in obtaining necessary equipment, supplies, materials, or related assistance or services.
- (H) Effectively using the services of available minority/women community organizations; minority/women contractors' groups; Federal, State, and local minority/women business assistance offices; and other organizations as allowed on a case-by-case basis to provide assistance in the recruitment and placement of MBEs/WBEs. Contact within 7 days from the bid opening the Business Opportunity and Work Force Development Unit at BOWD@ncdot.gov to give notification of the bidder's inability to get MBE or WBE quotes.
- (I) Any other evidence that the bidder submits which shows that the bidder has made reasonable good faith efforts to meet the advertised goal.

In addition, the Department may take into account the following:

- (1) Whether the bidder's documentation reflects a clear and realistic plan for achieving the Combined MBE/WBE goal.
- (2) The bidders' past performance in meeting the contract goal.
- (3) The performance of other bidders in meeting the advertised goal. For example, when the apparent successful bidder fails to meet the goal, but others meet it, you may reasonably raise the question of whether, with additional reasonable efforts the apparent successful bidder could have met the goal. If the apparent successful bidder fails to meet the advertised goal, but meets or exceeds the average MBE and WBE participation obtained by other bidders, the Department may view this, in conjunction with other factors, as evidence of the apparent successful bidder having made a good faith effort.

If the Department does not award the contract to the apparent lowest responsive bidder, the Department reserves the right to award the contract to the next lowest responsive bidder that can satisfy to the Department that the Combined MBE/WBE goal can be met or that an adequate good faith effort has been made to meet the advertised goal.

Non-Good Faith Appeal

The Engineer will notify the Contractor verbally and in writing of non-good faith. A Contractor may appeal a determination of non-good faith made by the Goal Compliance Committee. If a Contractor wishes to appeal the determination made by the Committee, they shall provide written notification to the Engineer. The appeal shall be made within 2 business days of notification of the determination of non-good faith.

Counting MBE/WBE Participation Toward Meeting the Combined MBE/WBE Goal**(A) Participation**

The total dollar value of the participation by a committed MBE/WBE will be counted toward the contract goal requirements. The total dollar value of participation by a committed MBE/WBE will be based upon the value of work performed by the MBE/WBE and the actual payments to MBE/WBE firms by the Contractor.

(B) Joint Checks

Prior notification of joint check use shall be required when counting MBE/WBE participation for services or purchases that involves the use of a joint check. Notification shall be through submission of Form JC-1 (*Joint Check Notification Form*) and the use of joint checks shall be in accordance with the Department's Joint Check Procedures.

(C) Subcontracts (Non-Trucking)

A MBE/WBE may enter into subcontracts. Work that a MBE subcontracts to another MBE firm may be counted toward the anticipated MBE participation. The same holds for work that a WBE subcontracts to another WBE firm. Work that a MBE/WBE subcontracts to a non-MBE/WBE firm does not count toward the contract goal requirement. It should be noted that every effort shall be made by MBE and WBE contractors to subcontract to the same certification (i.e., MBEs to MBEs and WBEs to WBEs), in order to fulfill the MBE or WBE participation breakdown. This, however, may not always be possible due to the limitation of firms in the area. If the MBE or WBE firm shows a good faith effort has been made to reach out to similarly certified firms and there is no interest or availability, and they can get assistance from other certified firms, the Engineer will not hold the prime responsible for meeting the individual MBE or WBE breakdown. If a MBE or WBE contractor or subcontractor subcontracts a significantly greater portion of the work of the contract than would be expected on the basis of standard industry practices, it shall be presumed that the MBE or WBE is not performing a commercially useful function.

(D) Joint Venture

When a MBE or WBE performs as a participant in a joint venture, the Contractor may count toward its contract goal requirement a portion of the total value of participation

with the MBE or WBE in the joint venture, that portion of the total dollar value being a distinct clearly defined portion of work that the MBE or WBE performs with its forces.

(E) Manufacturer, Regular Dealer, Distributor

A Contractor may count toward its MBE/WBE requirement 40 percent of its expenditures for materials or supplies (including transportation costs) from a MBE/WBE distributor, 60 percent of its expenditures for materials or supplies (including transportation costs) from a MBE/WBE regular dealer and 100 percent of such expenditures obtained from a MBE/WBE manufacturer.

A Contractor may count toward its MBE/WBE requirement the following expenditures to MBE/WBE firms that are not manufacturers, regular dealers or distributors:

- (1) The fees or commissions charged by a MBE/WBE firm for providing a *bona fide* service, such as professional, technical, consultant, or managerial services, or for providing bonds or insurance specifically required for the performance of a DOT-assisted contract, provided the fees or commissions are determined to be reasonable and not excessive as compared with fees and commissions customarily allowed for similar services.
- (2) With respect to materials or supplies purchased from a MBE/WBE, which is neither a manufacturer, regular dealer, nor a distributor count the entire amount of fees or commissions charged that the Department deems to be reasonable, including transportation charges for the delivery of materials or supplies. Do not count any portion of the cost of the materials and supplies themselves.

A Contractor will submit a completed *DBE Regular Dealer/Distributor Affirmation Form* with the Letter of Intent to the Engineer. The Engineer will forward to the State Contractor Utilization Engineer or DBE@ncdot.gov. The State Contractor Utilization Engineer will make a preliminary assessment as to whether a MBE/WBE supplier has the demonstrated capacity to perform a commercially useful function (CUF) on a contract-by-contract basis *prior* to its participation.

Commercially Useful Function

(A) MBE/WBE Utilization

The Contractor may count toward its contract goal requirement only expenditures to MBEs and WBEs that perform a commercially useful function in the work of a contract. A MBE/WBE performs a commercially useful function when it is responsible for execution of the work of the contract and is carrying out its responsibilities by performing, managing, and supervising the work involved. To perform a commercially useful function, the MBE/WBE shall also be responsible with respect to materials and supplies used on the contract, for negotiating price, determining quality and quantity, ordering the material and installing (where applicable) and paying for the material itself. To determine whether a MBE/WBE is performing a commercially useful function, the Department will evaluate the amount of work subcontracted, industry practices, whether

the amount the firm is to be paid under the contract is commensurate with the work it is performing and the MBE/WBE credit claimed for its performance of the work, and any other relevant factors. If it is determined that a MBE or WBE is not performing a Commercially Useful Function, the contractor may present evidence to rebut this presumption to the Department.

(B) MBE/WBE Utilization in Trucking

The following factors will be used to determine if a MBE or WBE trucking firm is performing a commercially useful function:

- (1) The MBE/WBE shall be responsible for the management and supervision of the entire trucking operation for which it is responsible on a particular contract, and there shall not be a contrived arrangement for the purpose of meeting the Combined MBE/WBE goal.
- (2) The MBE/WBE shall itself own and operate at least one fully licensed, insured, and operational truck used on the contract.
- (3) The MBE/WBE receives credit for the total value of the transportation services it provides on the contract using trucks it owns, insures, and operates using drivers it employs.
- (4) The MBE may subcontract the work to another MBE firm, including an owner-operator who is certified as a MBE. The same holds true that a WBE may subcontract the work to another WBE firm, including an owner-operator who is certified as a WBE. When this occurs, the MBE or WBE who subcontracts work receives credit for the total value of the transportation services the subcontracted MBE or WBE provides on the contract. It should be noted that every effort shall be made by MBE and WBE contractors to subcontract to the same certification (i.e., MBEs to MBEs and WBEs to WBEs), in order to fulfill the participation breakdown. This, however, may not always be possible due to the limitation of firms in the area. If the MBE or WBE firm shows a good faith effort has been made to reach out to similarly certified transportation service providers and there is no interest or availability, and they can get assistance from other certified providers, the Engineer will not hold the prime responsible for meeting the individual MBE or WBE participation breakdown.
- (5) The MBE/WBE may also subcontract the work to a non-MBE/WBE firm, including from an owner-operator. The MBE/WBE who subcontracts the work to a non-MBE/WBE is entitled to credit for the total value of transportation services provided by the non-MBE/WBE subcontractor not to exceed the value of transportation services provided by MBE/WBE-owned trucks on the contract. Additional participation by non-MBE/WBE subcontractors receives credit only for the fee or commission it receives as a result of the subcontract arrangement. The value of services performed under subcontract agreements between the MBE/WBE and the Contractor will not count towards the MBE/WBE contract requirement.

- (6) A MBE/WBE may lease truck(s) from an established equipment leasing business open to the general public. The lease must indicate that the MBE/WBE has exclusive use of and control over the truck. This requirement does not preclude the leased truck from working for others during the term of the lease with the consent of the MBE/WBE, so long as the lease gives the MBE/WBE absolute priority for use of the leased truck. This type of lease may count toward the MBE/WBE's credit as long as the driver is under the MBE/WBE's payroll.
- (7) Subcontracted/leased trucks shall display clearly on the dashboard the name of the MBE/WBE that they are subcontracted/leased to and their own company name if it is not identified on the truck itself. Magnetic door signs are not permitted.

MBE/WBE Replacement

When a Contractor has relied on a commitment to a MBE or WBE subcontractor (or an approved substitute MBE or WBE subcontractor) to meet all or part of a contract goal requirement, the contractor shall not terminate the MBE/WBE subcontractor or any portion of its work for convenience. This includes, but is not limited to, instances in which the Contractor seeks to perform the work of the terminated subcontractor with another MBE/WBE subcontractor, a non-MBE/WBE subcontractor, or with the Contractor's own forces or those of an affiliate.

The Contractor must give notice in writing both by certified mail and email to the MBE/WBE subcontractor, with a copy to the Engineer of its intent to request to terminate a MBE/WBE subcontractor or any portion of its work, and the reason for the request. The Contractor must give the MBE/WBE subcontractor five (5) business days to respond to the Contractor's Notice of Intent to Request Termination and/or Substitution. If the MBE/WBE subcontractor objects to the intended termination/substitution, the MBE/WBE, within five (5) business days must advise the Contractor and the Department of the reasons why the action should not be approved. The five-day notice period shall begin on the next business day after written notice is provided to the MBE/WBE subcontractor.

A committed MBE/WBE subcontractor may only be terminated or any portion of its work after receiving the Department's written approval based upon a finding of good cause for the proposed termination and/or substitution. Good cause does not exist if the Contractor seeks to terminate a MBE/WBE or any portion of its work that it relied upon to obtain the contract so that the Contractor can self-perform the work for which the MBE/WBE was engaged, or so that the Contractor can substitute another MBE/WBE or non-MBE/WBE contractor after contract award. For purposes of this section, good cause shall include the following circumstances:

- (a) The listed MBE/WBE subcontractor fails or refuses to execute a written contract;
- (b) The listed MBE/WBE subcontractor fails or refuses to perform the work of its subcontract in a way consistent with normal industry standards. Provided, however, that good cause does not exist if the failure or refusal of the MBE/WBE subcontractor to perform its work on the subcontract results from the bad faith or discriminatory action of the prime contractor;
- (c) The listed MBE/WBE subcontractor fails or refuses to meet the prime contractor's reasonable, nondiscriminatory bond requirements;

- (d) The listed MBE/WBE subcontractor becomes bankrupt, insolvent, or exhibits credit unworthiness;
- (e) The listed MBE/WBE subcontractor is ineligible to work on public works projects because of suspension and debarment proceedings pursuant to 2 CFR parts 180, 215 and 1200 or applicable State law;
- (f) The listed MBE/WBE subcontractor is not a responsible contractor;
- (g) The listed MBE/WBE voluntarily withdraws from the project and provides written notice of withdrawal;
- (h) The listed MBE/WBE is ineligible to receive MBE/WBE credit for the type of work required;
- (i) A MBE/WBE owner dies or becomes disabled with the result that the listed MBE/WBE contractor is unable to complete its work on the contract; and
- (j) Other documented good cause that compels the termination of the MBE/WBE subcontractor.

The Contractor shall comply with the following for replacement of a committed MBE/WBE:

(A) Performance Related Replacement

When a committed MBE/WBE is terminated for good cause as stated above, an additional MBE/WBE that was submitted at the time of bid may be used to fulfill the MBE/WBE commitment to meet the Combined MBE/WBE Goal. A good faith effort will only be required for removing a committed MBE/WBE if there were no additional MBE/WBEs submitted at the time of bid to cover the same amount of work as the MBE/WBE that was terminated.

If a replacement MBE/WBE is not found that can perform at least the same amount of work as the terminated MBE/WBE, the Contractor shall submit a good faith effort documenting the steps taken. Such documentation shall include, but not be limited to, the following:

- (1) Copies of written notification to MBE/WBEs that their interest is solicited in contracting the work defaulted by the previous MBE/WBE or in subcontracting other items of work in the contract.
- (2) Efforts to negotiate with MBE/WBEs for specific subbids including, at a minimum:
 - (a) The names, addresses, and telephone numbers of MBE/WBEs who were contacted.
 - (b) A description of the information provided to MBE/WBEs regarding the plans and specifications for portions of the work to be performed.
- (3) A list of reasons why MBE/WBE quotes were not accepted.
- (4) Efforts made to assist the MBE/WBEs contacted, if needed, in obtaining bonding or insurance required by the Contractor.

(B) Decertification Replacement

- (1) When a committed MBE/WBE is decertified by the Department after the SAF (*Subcontract Approval Form*) has been received by the Department, the Department will not require the Contractor to solicit replacement MBE/WBE participation equal to the remaining work to be performed by the decertified firm. The participation equal to the remaining work performed by the decertified firm will count toward the contract goal requirement but not the overall goal.
 - (i) If the MBE/WBE's ineligibility is caused solely by its having exceeded the size standard during the performance of the contract. The Department may continue to count participation equal to the remaining work performed by the decertified firm which will count toward the contract goal requirement and overall goal.
 - (ii) If the MBE/WBE's ineligibility is caused solely by its acquisition by or merger with a non- MBE/WBE during the performance of the contract. The Department may not continue to count the portion of the decertified firm's performance on the contract remaining toward either the contract goal or the overall goal, even if the Contractor has executed a subcontract with the firm or the Department has executed a prime contract with the MBE/WBE that was later decertified.
- (2) When a committed MBE/WBE is decertified prior to the Department receiving the SAF (*Subcontract Approval Form*) for the named MBE/WBE firm, the Contractor shall take all necessary and reasonable steps to replace the MBE/WBE subcontractor with another MBE/WBE subcontractor to perform at least the same amount of work to meet the Combined MBE/WBE goal requirement. If a MBE/WBE firm is not found to do the same amount of work, a good faith effort must be submitted to NCDOT (see A herein for required documentation).

All requests for replacement of a committed MBE/WBE firm shall be submitted to the Engineer for approval on Form RF-1 (*DBE Replacement Request*). If the Contractor fails to follow this procedure, the Contractor may be disqualified from further bidding for a period of up to 6 months.

Changes in the Work

When the Engineer makes changes that result in the reduction or elimination of work to be performed by a committed MBE/WBE, the Contractor will not be required to seek additional participation. When the Engineer makes changes that result in additional work to be performed by a MBE/WBE based upon the Contractor's commitment, the MBE/WBE shall participate in additional work to the same extent as the MBE/WBE participated in the original contract work.

When the Engineer makes changes that result in extra work, which has more than a minimal impact on the contract amount, the Contractor shall seek additional participation by MBEs/WBEs unless otherwise approved by the Engineer.

When the Engineer makes changes that result in an alteration of plans or details of construction, and a portion or all of the work had been expected to be performed by a committed MBE/WBE, the Contractor shall seek participation by MBEs/WBEs unless otherwise approved by the Engineer.

When the Contractor requests changes in the work that result in the reduction or elimination of work that the Contractor committed to be performed by a MBE/WBE, the Contractor shall seek additional participation by MBEs/WBEs equal to the reduced MBE/WBE participation caused by the changes.

Reports and Documentation

A SAF (*Subcontract Approval Form*) shall be submitted for all work which is to be performed by a MBE/WBE subcontractor. The Department reserves the right to require copies of actual subcontract agreements involving MBE/WBE subcontractors.

When using transportation services to meet the contract commitment, the Contractor shall submit a proposed trucking plan in addition to the SAF. The plan shall be submitted prior to beginning construction on the project. The plan shall include the names of all trucking firms proposed for use, their certification type(s), the number of trucks owned by the firm, as well as the individual truck identification numbers, and the line item(s) being performed.

Within 30 calendar days of entering into an agreement with a MBE/WBE for materials, supplies or services, not otherwise documented by the SAF as specified above, the Contractor shall furnish the Engineer a copy of the agreement. The documentation shall also indicate the percentage (60% or 100%) of expenditures claimed for MBE/WBE credit.

Reporting Minority and Women Business Enterprise Participation

The Contractor shall provide the Engineer with an accounting of payments made to all MBE and WBE firms, including material suppliers and contractors at all levels (prime, subcontractor, or second tier subcontractor). This accounting shall be furnished to the Engineer for any given month by the end of the following month. Failure to submit this information accordingly may result in the following action:

- (A) Withholding of money due in the next partial pay estimate; or
- (B) Removal of an approved contractor from the prequalified bidders' list or the removal of other entities from the approved subcontractors list.

While each contractor (prime, subcontractor, 2nd tier subcontractor) is responsible for accurate accounting of payments to MBEs/WBEs, it shall be the prime contractor's responsibility to report all monthly and final payment information in the correct reporting manner.

Failure on the part of the Contractor to submit the required information in the time frame specified may result in the disqualification of that contractor and any affiliate companies from further bidding until the required information is submitted.

Failure on the part of any subcontractor to submit the required information in the time frame specified may result in the disqualification of that contractor and any affiliate companies from being approved for further work on future projects until the required information is submitted.

Contractors reporting transportation services provided by non-MBE/WBE lessees shall evaluate the value of services provided during the month of the reporting period only.

At any time, the Engineer can request written verification of subcontractor payments. The Contractor shall report the accounting of payments through the Department's DBE Payment Tracking System.

Failure to Meet Contract Requirements

Failure to meet contract requirements in accordance with Subarticle 102-15(J) of the *Standard Specifications* may be cause to disqualify the Contractor.

RESTRICTIONS ON ITS EQUIPMENT AND SERVICES:

(11-17-20)

SP01 G090

All telecommunications, video or other ITS equipment or services installed or utilized on this project must be in conformance with UNIFORM ADMINISTRATIVE REQUIREMENTS, COST PRINCIPLES, AND AUDIT REQUIREMENTS FOR FEDERAL AWARDS **2 CFR, § 200.216 Prohibition on certain telecommunications and video surveillance services or equipment.**

USE OF UNMANNED AIRCRAFT SYSTEM (UAS):

(8-20-19)(Rev. 8-19-25)

SP1 G092

The Contractor shall adhere to all Federal, State and Local regulations and guidelines for the use of Unmanned Aircraft Systems (UAS). This includes but is not limited to US 14 CFR Part 107, NC GS 15A-300, all FAA rules, regulations and policies and all NCDOT UAS Policies. The required operator certifications include possessing a current Federal Aviation Administration (FAA) Remote Pilot Certificate, as well as operating a UAS registered with the FAA.

All UAS operations shall be approved by the Engineer prior to beginning the operations.

All contractors or subcontractors operating UAS shall have UAS specific general liability insurance to cover all operations under this contract.

The use of UAS is at the Contractor's discretion. No measurement or payment will be made for the use of UAS. In the event that the Department directs the Contractor to utilize UAS, payment will be in accordance with Article 104-7 Extra Work.

EQUIPMENT IDLING GUIDELINES:

(1-19-21)

107

SP1 G096

Exercise reduced fuel consumption and reduced equipment emissions during the construction of all work associated with this contract. Employees engaged in the construction of this project should turn off vehicles when stopped for more than thirty (30) minutes and off-highway equipment should idle no longer than fifteen (15) consecutive minutes.

These guidelines for turning off vehicles and equipment when idling do not apply to:

1. Idling when queuing.
2. Idling to verify the vehicle is in safe operating condition.
3. Idling for testing, servicing, repairing or diagnostic purposes.
4. Idling necessary to accomplish work for which the vehicle was designed (such as operating a crane, mixing concrete, etc.).
5. Idling required to bring the machine system to operating temperature.
6. Emergency vehicles, utility company, construction, and maintenance vehicles where the engines must run to perform needed work.
7. Idling to ensure safe operation of the vehicle.
8. Idling when the propulsion engine is providing auxiliary power for other than heating or air conditioning. (such as hydraulic systems for pavers)
9. When specific traffic, safety, or emergency situations arise.
10. If the ambient temperature is less than 32 degrees Fahrenheit. Limited idling to provide for the safety of vehicle occupants (e.g. to run the heater).
11. If the ambient temperature is greater than 90 degrees Fahrenheit. Limited idling to provide for the safety of vehicle occupants of off-highway equipment (e.g. to run the air conditioning) no more than 30 minutes.
12. Diesel powered vehicles may idle for up to 30 minutes to minimize restart problems.

Any vehicle, truck, or equipment in which the primary source of fuel is natural gas or electricity is exempt from the idling limitations set forth in this special provision.

OUTSOURCING OUTSIDE THE USA:

(9-21-04) (Rev. 5-16-06)

SP1 G150

All work on consultant contracts, services contracts, and construction contracts shall be performed in the United States of America. No work shall be outsourced outside of the United States of America.

Outsourcing for the purpose of this provision is defined as the practice of subcontracting labor, work, services, staffing, or personnel to entities located outside of the United States.

The North Carolina Secretary of Transportation shall approve exceptions to this provision in writing.

PROJECT SPECIAL PROVISIONS**ROADWAY****CONSTRUCTION SEQUENCE:**

(7-1-95) (Rev. 8-21-12)

560

SP1 R34R

Pave each section of roadway begun in a continuous operation. Do not begin work on another section of roadway unless satisfactory progress is being made toward completion of intersections and all other required incidental work by satisfactorily furnishing additional paving equipment and personnel, except for milling and patching operations.

INCIDENTAL STONE BASE:

(7-1-95)(Rev.1-16-24)

545

SP5 R28R

Description

Place incidental stone base on driveways, mailboxes, etc. immediately after paving and do not have the paving operations exceed stone base placement by more than one week without written permission of the Engineer.

Materials and Construction

Provide and place incidental stone base in accordance with Section 545 of the *Standard Specifications*.

Measurement and Payment

Incidental Stone Base will be measured and paid in accordance with Article 545-6 of the *Standard Specifications*.

SHOULDER WEDGE:

(9-20-11)(Rev. 1-16-24)

610

SP6 R03R

Revise the *Standard Specifications* as follows:

Page 6-21, Article 610-8, SPREADING AND FINISHING, add the following after line 40:

Attach a device, mounted on screed of paving equipment, capable of constructing a shoulder wedge with an angle of 30 degrees plus or minus 4 degrees along the outside edge of the roadway, measured from the horizontal plane in place after final compaction on the final surface course. Use an approved mechanical device which will form the asphalt mixture to produce a wedge with uniform texture, shape and density while automatically adjusting to varying heights.

Payment for use of this device will be incidental to the other pay items in the contract.

PRICE ADJUSTMENT - ASPHALT BINDER FOR PLANT MIX:

(11-21-00)(Rev. 1-16-24)

620

SP6 R25

Price adjustments for asphalt binder for plant mix will be made in accordance with Section 620 of the *Standard Specifications*.

The base price index for asphalt binder for plant mix is **\$555.00** per ton.

This base price index represents an average of F.O.B. selling prices of asphalt binder at supplier's terminals on **December 1, 2025**.

DELETION OF FINAL SURFACE TESTING REQUIREMENTS:

(1-20-25)

610

SP6 R045A

Revise the *Standard Specifications* as follows:

Pages 6-24 to 6-30, Article 610-13 FINAL SURFACE TESTING AND ACCEPTANCE, delete Article 610-13 in its entirety.

MILLED RUMBLE STRIPS ON ASPHALT CONCRETE SHOULDERS:

(11-19-24)(Rev. 6-17-25)

665

SP6 R56

Revise the *Standard Specifications* as follows:

Page 6-53, Article 665-3 CONSTRUCTION METHODS, lines 20-21, delete and replace the first sentence of the second paragraph with the following:

Provide rumble strips that have finished dimensions of 7 inches \pm 1/2 inch wide in the direction of travel and the length measured perpendicular to the direction of travel as specified in the contract.

Page 6-53, Article 665-4 MEASUREMENT AND PAYMENT, lines 30-33, delete and replace with the following:

Milled Rumble Strips (Asphalt Concrete), ___" will be measured and paid at the contract unit price per linear foot for the actual number of linear feet, measured longitudinally along the surface of each shoulder and/or edgeline, where rumble strips have been constructed.

Payment will be made under:

Pay Item	Pay Unit
Milled Rumble Strips (Asphalt Concrete), ___"	Linear Foot

CENTERLINE MILLED RUMBLE STRIPS ON ASPHALT CONCRETE:

(4-18-23)(Rev. 11-19-24)

665

SP6 R57

Description

Construct centerline milled rumble strips on asphalt concrete in accordance with the plans, Section 665 of the *Standard Specifications* and as directed by the Engineer.

Construction Method

Construct centerline milled rumble strips in accordance with the applicable requirements of Section 665 of the *Standard Specifications* and as directed by the Engineer.

Measurement and Payment

Centerline Milled Rumble Strips (Asphalt Concrete), ___" will be measured and paid at the contract unit price per linear foot for the actual number of linear feet of centerline, measured longitudinally along the surface of centerline, where rumble strips have been constructed.

Payment will be made under:

Pay Item

Centerline Milled Rumble Strips (Asphalt Concrete), ___"

Pay Unit

Linear Foot

RESURFACING EXISTING BRIDGES (with Milling):

(3-20-12) (Rev. 8-21-12)

SP6 R61BR

The Contractor's attention is directed to the fact that he will be required to mill and resurface the bridges on this project if directed by the Engineer.

Place the surface so as to follow a grade line set by the Engineer with the minimum thickness as shown on the sketch herein or as directed by the Engineer. State Forces will make all necessary repairs to the bridge floors prior to the time that the Contractor places the proposed surfacing. Give the Engineer at least 15 days' notice prior to the expected time to begin operations so that State Forces will have sufficient time to complete their work.

At all bridges that are not to be resurfaced, mill a taper into existing pavement for a length of 25 feet per inch of final surface. A temporary asphalt wedge will be required immediately after milling to ensure smooth travel if the final layer of surface course is not placed on the same day as milling.

PATCHING EXISTING PAVEMENT:

(1-15-02) (Rev. 1-16-24)

610

SP6 R88

Description

The Contractor's attention is directed to the fact that there are areas of existing pavement on this project that will require repair prior to resurfacing. Patch the areas that, in the opinion of the Engineer, need repairing. The areas to be patched will be delineated by the Engineer prior to the Contractor performing repairs.

Materials

The patching consists of Asphalt Concrete Base Course, Asphalt Concrete Intermediate Course, Asphalt Concrete Surface Course, or a combination of base, intermediate and surface course.

Construction Methods

Remove existing pavement at locations directed by the Engineer in accordance with Section 250 of the *Standard Specifications*.

Place Asphalt Concrete Base Course in lifts not exceeding 5.5 inches. Utilize compaction equipment suitable for compacting patches as small as 3.5 feet by 6 feet on each lift. Use an approved compaction pattern to achieve proper compaction. If patched pavement is to be open to traffic between December through March of the following year, use Asphalt Concrete Intermediate Course or Asphalt Concrete Surface Course as the top layer of the patch.

Schedule operations so that all areas where pavement has been removed will be repaired on the same day of the pavement removal and all lanes of traffic restored.

Measurement and Payment

Patching Existing Pavement will be measured and paid as the actual number of tons of asphalt plant mix complete in place that has been used to make completed and accepted repairs. The asphalt plant mixed material will be measured by being weighed in trucks on certified platform scales or other certified weighing devices. The above price and payment will be full compensation for all work covered by this provision, including but not limited to removal and disposal of all types of pavement; furnishing and applying tack coat; furnishing, placing, and compacting of asphalt plant mix; and furnishing scales.

Furnishing asphalt binder will be paid as provided in Article 620-4 for *Asphalt Binder for Plant Mix* for each grade required.

Payment will be made under:

Pay Item	Pay Unit
Patching Existing Pavement	Ton

ELECTRONIC TICKETING SYSTEM:

(7-16-24)(Rev. 12-17-24)

1020

SP10 R20

Description

At the contractor's option, the use of an electronic ticketing system for reporting individual and cumulative asphalt material deliveries may be utilized on this project. At the preconstruction conference, the contractor shall notify the Engineer if they intend to utilize an electronic ticketing system for reporting individual and cumulative asphalt material deliveries to the project.

Electronic Ticketing Requirements

- a. The electronic ticketing system must be fully integrated with the load read-out system at the plant. The system shall be designed so data inputs from scales cannot be altered by either the Contractor or the Department.

- b. Material supplier must test to confirm that ticketing data can be shared from the originating system no less than 30 days prior to project start.
- c. After each truck is loaded, ticket data must be electronically captured, and ticket information uploaded via Application Programming Interface (API) to the Department.
- d. Obtain security token from NCDOT for access to E-Ticketing portal (to send tickets). To request a Security Key, fill out the below E-Ticketing Security Request Form: <https://forms.office.com/g/XnT7QeRtgt>
- e. Obtain API from NCDOT containing the required e-ticketing data fields and format. Download the API from the NCDOT E-ticketing Webpage: <https://connect.ncdot.gov/projects/construction/E-Ticketing/Pages/default.aspx>
- f. Provide all ticket information in real time and daily summaries to the Department's designated web portal. If the project contains locations with limited cellular service, an alternative course of action must be agreed upon.
- g. Electronic ticketing submissions must be sent between the Material Supplier and the Department.
- h. The electronic ticket shall contain the following information:

- Date
- Contract Number
- Supplier Name
- Contractor Name
- Material
- JMF
- Gross Weight
- Tare Weight
- Net Weight
- Load Number
- Cumulative Weight
- Truck Number
- Weighmaster Certification
- Weighmaster Expiration
- Weighmaster Name
- Facility Name
- Plant Certification Number
- Ticket Number
- Hauling Firm (optional)
- Voided Ticket Number (if necessary)
- Original Ticket Number (if necessary)
- Supplier Revision (If necessary)

The Contractor/supplier can use the electronic ticketing system of their choice to meet the requirements of this provision.

Measurement and Payment

No measurement or payment will be made for utilizing an electronic ticketing system as the cost of such shall be included in the contract price bid for the material being provided.

GLASS BEAD GRADATION FOR PAVEMENT MARKINGS:

(9-17-24)

1087

SP10 R87

Revise the *Standard Specifications* as follows:

Page 10-187, Subarticle 1087-4(C), Gradation & Roundness, after line 6, delete and replace Table 1087-2 with the following:

TABLE 1087-2 GLASS BEAD GRADATION REQUIREMENTS		
Sieve Size	Gradation Requirements	
	Minimum	Maximum
Passing #20	100%	--
Retained on #30	5%	15%
Retained on #50	40%	80%
Retained on #80	15%	40%
Passing #80	0%	10%
Retained on #200	0%	5%

CONES:

(3-19-24)

1135

SP11 R35

Revise the *Standard Specifications* as follows:

Page 11-11, Article 1135-3 CONSTRUCTION METHODS, lines 19-20, delete the third sentence of the first paragraph, "Do not use cones in the upstream taper of lane or shoulder closures for multi-lane roadways."

FLAGGERS:

(12-17-24)(Rev. 12-23-25)

1150

SP11 R50

Revise Section 1150 of the *Standard Specification* as follows:

Page 11-13, Article 1150-1, DESCRIPTION, add the following after line 31:

Alternatively, at the discretion of the Contractor, the Contractor may furnish, install, place in operation, repair, maintain, relocate, and remove remotely controlled Automated Flagging Assistance Devices (AFAD) or Temporary Portable Traffic Signal units (PTS units) to assist, supplement, or replace human flaggers for one-lane, two-way traffic maintenance during construction in accordance with this provision and the *Standard Specifications*.

For the purpose of this provision, an "approach" refers to a single lane of traffic moving in one direction toward a point of control or work zone. Flaggers, AFAD and PTS units are only used to control one lane of approaching traffic in a specific direction.

Page 11-13, Article 1150-2, MATERIALS, add the following after line 34:

Provide documentation to the Engineer that the AFAD or PTS units meets or exceeds the requirements of this special provision and is on the NCDOT APL or ITS and Signals QPL.

(A) Automated Flagging Assistance Devices (AFAD)

(1) AFAD General

Cover the automated gate arm with Department approved Type VII, VIII or IX retroreflective sheeting of vertical alternating red and white stripes at 16 inch intervals measured horizontally. When the gate arm is in the down position the minimum vertical aspect of the arm and sheeting shall be 4 inches. The retroreflectorized sheeting shall be on both sides of the gate arm. With the AFAD parked or positioned 2 feet outside or in a location deemed acceptable for the lane being controlled, the gate arm shall reach at least to the center of the lane but shall not exceed the width of the lane being controlled.

Design the system to be fail-safe. Provide a conflict monitor, malfunction monitoring unit, or similar device that monitors for malfunctions and prevents the display of conflicting indications. This system shall be electronic and operated by remote control.

(2) AFAD Type I System: RED/YELLOW

Provide a Red/Yellow AFAD with at least one set of CIRCULAR RED and CIRCULAR YELLOW lenses in a vertical configuration that are 12 inches in diameter. The bottom of the housing (including brackets) shall be at least 7 feet (2.1 meters) above the pavement.

This system is required to have yellow 12 inch aluminum or polycarbonate vehicle signal heads with 10 inch tunnel visors, backplates, and Light Emitting Diode (LED) modules. Provide signal heads, backplates, and LED modules listed on the ITS and Signals QPL available on the Department's website.

Provide an automated gate arm on the AFAD that descends to a down position across the approaching lane of traffic when the steady CIRCULAR RED lens is illuminated and then ascends to an upright position when the flashing CIRCULAR YELLOW lens is illuminated. The automated gate arm is to be designed such that if a motorist pulls underneath the gate arm while lowering, no damage to the vehicle occurs.

A STOP HERE ON RED (R10-6 or R10-6a) sign shall be installed on the right-hand side of the approach at the point at which drivers are expected to stop when the steady CIRCULAR RED lens is illuminated.

To stop traffic, the AFAD shall transition from the flashing CIRCULAR YELLOW lens by initiating a minimum 5 second steadily illuminated CIRCULAR YELLOW lens followed by the CIRCULAR RED lens.

Once the CIRCULAR RED lens is displayed, the system is to have a minimum 2 second delay between the time the steady CIRCULAR RED is displayed and the time the gate arm begins to lower. The maximum delay between CIRCULAR RED and the time the gate arm lowers is 4 seconds. To permit stopped road users to proceed, the AFAD shall display the flashing CIRCULAR YELLOW lens and the gate arm shall be placed in the upright position.

Ensure the system monitors for a lack of yellow or red signal voltage, total loss of indication in any direction, presence of multiple indications on any approach and low power conditions.

Additional sets of CIRCULAR RED and CIRCULAR YELLOW lenses located over the roadway or on the left side of the approach and operated in unison with the primary set, may be used to improve visibility of the AFAD. If the set of lenses is located over any portion of the roadway that can be used by motor vehicles, the bottom of the housing (including brackets) shall be at least 15 feet (4.6 meters) above the pavement.

(3) AFAD Type II System: STOP/SLOW

Provide STOP/SLOW signs that are octagonal in shape, made of rigid material, and at least 36 inch x 36 inch in size. Letters shall be a minimum of 8 inches high. The STOP face shall have a red background with white letters and border.

The SLOW face shall be diamond shaped, orange, or yellow background with black letters and border. Cover both faces in a Department approved Type VII, VIII or IX retroreflective sheeting. The minimum mounting height for the sign faces shall be 7 feet above the pavement to the bottom of the sign.

The AFAD's STOP/SLOW signs shall be supplemented with active conspicuity devices by incorporating a stop beacon (red lens) and a warning beacon (yellow lens). The stop beacon shall be no more than 24 inches above the STOP face. Mount the warning beacon no more than 24 inches above or beside of the SLOW face. Except for the mounting locations, the beacons shall conform to the provisions of Chapter 4L of the MUTCD and have 12 inch signal lenses.

Strobe/flashing lights are an acceptable alternative to flashing beacons. If utilized, they shall be either white or red flashing lights located within the STOP face and white or yellow flashing lights within the SLOW face and conform to the provisions of Chapter 6D of the MUTCD. If used, the lens diameter shall be a minimum of 5 inches with a minimum height of 6 inches. Equip strobes/flashing lights for both dual and quad flash patterns.

Type B warning lights shall not be used in lieu of the beacons or the strobe lights.

The faces of the AFADs STOP/SLOW sign may include louvers. If louvers are used, design the louvers such that the aspect of the sign face to approaching traffic is a full sign face at a distance of 50 feet or greater.

A WAIT ON STOP (R1-7) sign and a GO ON SLOW (R1-8) sign shall be displayed to traffic approaching the AFAD. Position signs on the same support structure as the AFAD. Both signs shall have black legends and borders on white Type III sheeting backgrounds. Each of these signs shall be rectangular in shape and be at least 24 inch x 30 inch size with letters at least 6 inches high.

Provide an automated gate arm on the AFAD that descends to a down position across the approaching lane of traffic when the STOP face is displayed and then ascends to an upright position when the SLOW face is displayed.

The automated gate arm is to be designed such that if a motorist pulls underneath the gate arm while lowering, no damage to the vehicle occurs.

A STOP HERE ON RED (R10-6 or R10-6a) sign shall be installed on the right-hand side of the approach at the point at which drivers are expected to stop when the STOP face is displayed.

When approaching motorists are to proceed, display the SLOW face and the warning beacon or strobes are to flash on the AFAD. When approaching motorists are will be stopped, display the STOP face and the stop beacon or strobes are to flash on the AFAD.

To stop traffic, the AFAD will transition from the SLOW face to the STOP face by initiating a minimum 5 second change cycle. First, the warning beacon is to be steadily illuminated for the change cycle. If strobes are used in lieu of a warning beacon, they are to be placed in the quad flash pattern. At the end of the change cycle, the STOP face is to be displayed with the stop beacon flashing and the warning beacon or strobes are to stop flashing. Once the STOP face is displayed, the system is to have a minimum 2 second delay between the time the STOP face is displayed and the time the gate arm begins to lower. The maximum delay between the time the STOP face is displayed and the time the gate arm lowers is 4 seconds.

To permit stopped road users to proceed, the gate arm shall be placed in the upright position and the AFAD shall display the SLOW face and the warning beacon or strobes are to flash in the dual flash pattern.

Do not flash the stop beacon when the SLOW face is displayed, and do not flash the warning beacon when the STOP face is displayed.

(B) Portable Traffic Signals (PTS) Units

Provide PTS units with at least one set of CIRCULAR RED, CIRCULAR YELLOW, and CIRCULAR GREEN lenses in a vertical configuration that are 12 inch diameter aluminum or polycarbonate vehicle signal heads with 10 inch tunnel visors, backplates,

and Light Emitting Diode (LED) modules. All signal heads, tunnel visors, and backplates shall be yellow in color.

The bottom of the housing (including brackets) shall be at least 7 feet above the pavement for single set units. Additional signal heads on units with more than one signal head shall be capable of extending over the travel lane.

Communication Requirements

All PTS units within the signal set up systems shall maintain communication at all times by either hardwire cable or wireless radio link communication. If the hardwire cable communication is utilized the communication cable shall be deployed in a manner that will not intrude in the direct work area of the project or obstruct vehicular and pedestrian traffic. Utilize radio communication with 900MHz frequency band and frequency hopping capability. The radio link communication system shall have a minimum range of 1 mile.

Fault Mode Requirements

Revert PTS units to a flashing red mode upon system default unless otherwise specified by the Engineer. Equip the PTS units with a remote monitoring system. Where cell communication availability exists, the remote monitoring system shall adhere to the remote monitoring system section of this provision.

Remote Monitoring System

The remote monitoring system (RMS) shall be capable of reporting signal location, battery voltage / battery history and system default. Provide a password protected website viewable from any computer with internet capability for the RMS. In the event of a system default, the RMS shall provide specific information concerning the cause of the system default (i.e. red lamp on signal number 1). Equip the RMS with a mechanism capable of immediately contacting a minimum of three previously designated individuals via text messaging and/or email upon a default.

The running program operating the PTS units shall be always available and viewable through the RMS website. Maintain a history of the RMS operating system in each signal including operating hours and events and the location of the PTS units.

Trailer / Cart

The AFAD and PTS units may be mounted on either a trailer or a moveable cart system.

Finish all exterior metal surfaces with Federal orange enamel per AMS-STD-595, color chip ID# 13538 or 12473 respectively with a minimum paint thickness of 2.5 mils (64 microns).

Design and test the AFAD or PTS units trailer / cart to withstand an 80 MPH wind load while in the operational position. Provide independent certification that the assembly meets the design wind load.

Equip the AFAD or PTS units with leveling jacks capable of stabilizing the unit in a horizontal position when located on slopes 6:1 or flatter.

Equip trailers in compliance with North Carolina Law governing motor vehicles and include a 12-volt trailer lighting system complying with *Federal Motor Carrier Safety Regulations 393*, safety chains and a minimum 2 inch ball hitch.

Provide a minimum 4 inch wide strip of fluorescent conspicuity sheeting retroreflective sheeting to the frame of the trailer. Apply the sheeting to all sides of the trailer. The sheeting shall meet the ASTM requirements of Type VII, VIII or IX.

Power System

Design the systems to operate both with and without an external power source. Furnish transmitters, generators, batteries, controls and all other components necessary to operate the device.

Provide equipment that is solar powered and supplemented with a battery backup system that includes a minimum 110/120 VAC powered on-board charging system capable of powering the unit for 7 continuous days with no solar power. Each unit shall also be capable of being powered by standard 110/120 VAC power sources, if applicable.

Locate batteries and electronic controls in a locked, weather and vandal resistant housings.

Page 11-14, Article 1150-3, CONSTRUCTION METHODS, add the following after line 11:

Flaggers shall have a path to escape an errant approaching vehicle at all times, unimpeded by barrier, guardrail, guiderail, parked vehicles, construction materials, slopes steeper than 2:1, or any other obstruction at all times. If an unimpeded path cannot be maintained, the Contractor shall use AFAD or PTS units in lieu of a flagger.

Provide documentation to the Engineer prior to deploying the device that the AFAD or PTS units operator(s) are qualified flagger(s) that have been properly trained through an NCDOT approved training agency or other NCDOT approved training provider and that the qualified flagger(s) have received manufacturer training to operate that specific device. This training shall include proper installation, remote control operation, central control systems and maintenance of the AFAD or PTS units. The training shall take place off the project site where training conditions are removed from live traffic. The documentation shall include the names of the authorized trainer, the trainees, the device on which they have been trained and the date of the training. Provide updated documentation to the Engineer prior to deploying any additional operators.

Install advance warning signs and operate AFADs in accordance with the attached detail drawings in this provision.

Install advance warning signs and operate PTS units in accordance with *NCDOT Roadway Standard Drawings* No. 1101.02, Sheet 17.

AFAD and PTS units shall only be used in situations where there is only one lane of approaching traffic in the direction to be controlled. **At no time shall an AFAD unit controlling traffic through the work area be placed in an autonomous mode and/or left unattended.**

Signal timing and operation of PTS units shall be field verified and accepted by the Engineer before use.

Do not use AFAD or PTS units in locations where queueing from the AFAD or PTS units will extend to within 150 feet of a signalized intersection or railroad crossing. Do not use AFAD and PTS units as a substitute for or a replacement for a continuously operating temporary traffic control signal as described in Section 6F.84 of the MUTCD.

If used at night, illuminate each AFAD or PTS units as described in Section 6D of the MUTCD.

Provide a complete AFAD or PTS units that is capable of being relocated as traffic conditions demand.

If AFADs or PTS units become inoperative, be prepared at all times to replace the unit with the same type and model of AFAD or PTS units, revert to human flagging operations or terminate all construction activities requiring the use of the AFAD or PTS units until the AFAD or PTS units become operative or qualified human flaggers are available.

When the work requiring the AFAD or PTS units is not pursued for 30 minutes or longer, power off each AFAD or PTS units. Removed the AFAD or PTS units from the travel lane and relocated to a minimum of 5 feet from the edge line. AFAD gate arms shall be in the upright position. Remove all traffic control devices from the road, place two cones by each AFAD or PTS units and all signs associated with the lane closure operation shall be removed or laid down. At the end of each workday, remove all AFADs or PTS units from the roadway and shoulder areas.

Ensure the system's wireless communication links continuously monitor and verify proper transmission and reception of data used to monitor and control each AFAD or PTS units. Ensure ambient mobile or other radio transmissions or adverse weather conditions do not affect the system.

In the event of a loss of communications, immediately display the flashing RED or STOP indication on all AFAD or PTS units.

AFAD Specific Construction Methods

The flagger/operator controlling the AFAD units shall be on the project site at all times. If multiple AFAD units are used, one AFAD unit shall be the Main AFAD unit and all other units shall be remote AFAD units. Ensure that each device meets the physical display and operational characteristics as specified in the MUTCD.

Multiple AFAD units may be controlled with **one** flagger/operator when the AFAD units meet each of the following requirements:

- (1) AFAD units are spaced no greater than the manufacturer's recommendations.
- (2) Both AFAD units can be seen at the same time from the flagger/operator's position, or the AFAD is operating on its own secure network with malfunction detection and notification to the flagger/operator.
- (3) The flagger/operator has an unobstructed view of approaching traffic in both directions from the flagger/operator position or the AFAD is operating on its own secure network, with cameras that provide the flagger/operator an unobstructed view of approaching traffic from both directions. The flagger/operator may control the AFAD units from a pilot vehicle.

If any of the above requirements are not met, flagger/operator control each AFAD unit.

AFAD operators may either control traffic at side streets or driveways between the AFAD units or operate the pilot car while operating the AFAD system if approved by the Engineer. AFAD units must continue to be within clear sight of the operator during these work activities.

Page 11-14, Article 1150-4, MEASUREMENT AND PAYMENT, add the following after line 24:

Each AFAD or PTS unit will be measured and paid for as *Flaggers* paid by day in accordance with Article 1150-4 of the *Standard Specifications*. Where the pay item for *Flaggers* is not included in the original contract then no separate payment will be made for this item and payment will be included in the lump sum price bid for *Temporary Traffic Control* found elsewhere in this contract. Each approach controlled by AFAD or PTS units will be measured and paid as one flagger, irrespective of the number of devices used. If multiple PTS units are required to control a single approach, these units will collectively be considered as replacing one flagger.

No separate measurement or payment will be made for AFAD or PTS unit operators, as the cost of such including their training and operational costs shall be included in the unit or lump sum price for *Flaggers* or *Temporary Traffic Control*. Such price and payment also includes the relocation, maintenance, and removal during repair periods of AFAD or PTS units as well as the signal controller, communication, vehicle detection system, traffic signal software of PTS units and any other incidentals necessary to complete the work.

Red/Yellow Lens AFAD (TYPE I)

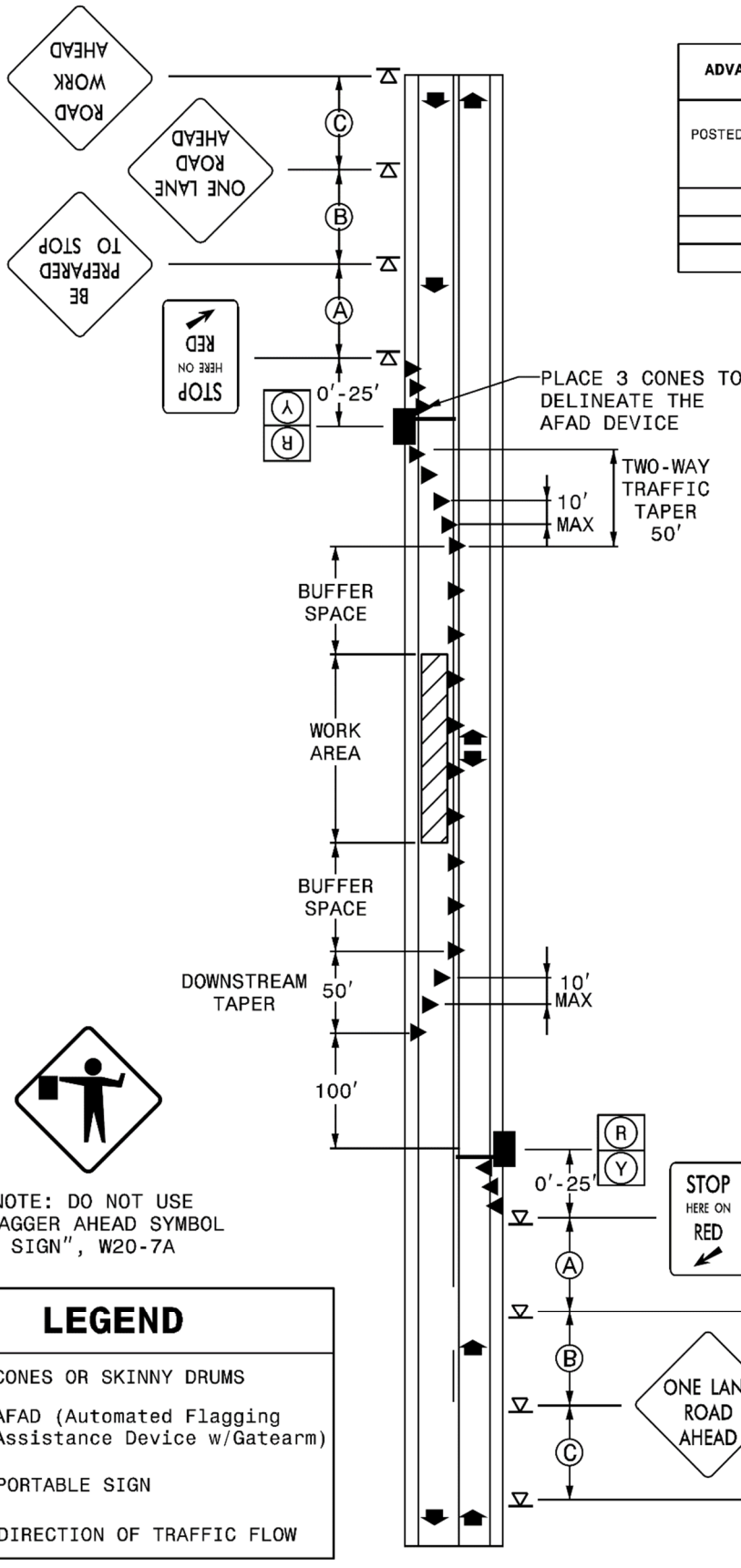

ADVANCE WARNING SIGN SPACING CHART			
POSTED SPEED LIMIT (MPH)	RECOMMENDED DISTANCE BETWEEN SIGNS FEET (+/-) SEE NOTE #1		
	(A)	(B)	(C)
≤ 35	200	200	200
40-50	350	350	350
55	500	500	500

DESIGN SPEED (MPH)	BUFFER SPACE (FEET)
30	85
35	120
40	155
45	195
50	240
55	290
60	345
65	405
70	470
75	540
80	615

NOTE: DO NOT USE "FLAGGER AHEAD SYMBOL SIGN", W20-7A

LEGEND

- CONES OR SKINNY DRUMS
- AFAD (Automated Flagger Assistance Device w/Gatearm)
- PORTABLE SIGN
- DIRECTION OF TRAFFIC FLOW

Stop/Slow AFAD (TYPE II)



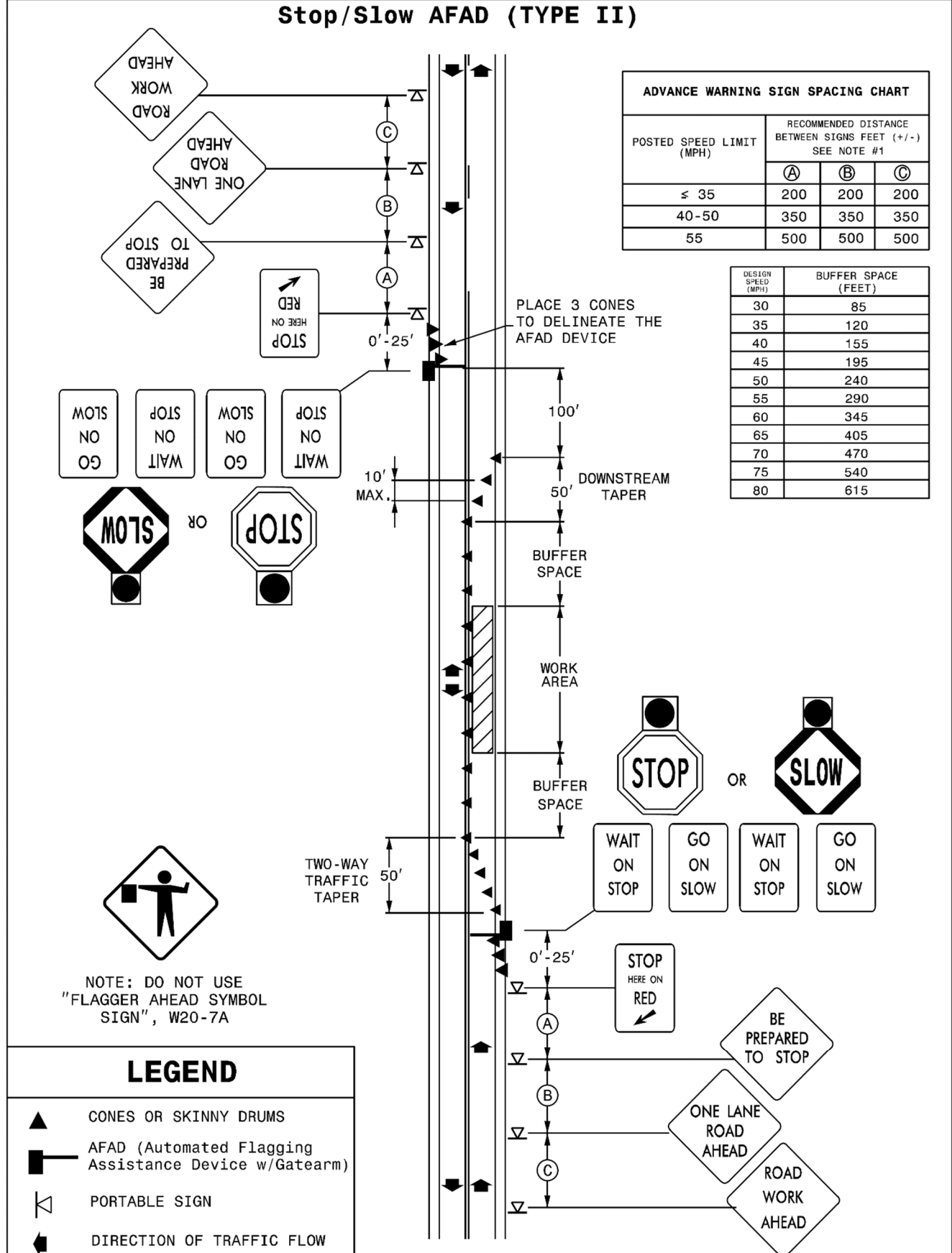

ADVANCE WARNING SIGN SPACING CHART			
POSTED SPEED LIMIT (MPH)	RECOMMENDED DISTANCE BETWEEN SIGNS FEET (+/-) SEE NOTE #1		
	(A)	(B)	(C)
≤ 35	200	200	200
40-50	350	350	350
55	500	500	500

DESIGN SPEED (MPH)	BUFFER SPACE (FEET)
30	85
35	120
40	155
45	195
50	240
55	290
60	345
65	405
70	470
75	540
80	615



NOTE: DO NOT USE "FLAGGER AHEAD SYMBOL SIGN", W20-7A

LEGEND

-  CONES OR SKINNY DRUMS
-  AFAD (Automated Flagging Assistance Device w/Gatearm)
-  PORTABLE SIGN
-  DIRECTION OF TRAFFIC FLOW

SNOWPLOWABLE DELINEATION:

(10-15-24)

1253

SP12 R53 (revised)

Description

Furnish, install and maintain snowplowable delineation.

There are five snowplowable delineation alternate options approved for use in North Carolina. They include the following markers and markings options:

- (1) Polycarbonate H-shaped Markers
- (2) Inlaid Raised Pavement Markers
- (3) 10' Rumble Skips
- (4) Inlaid Cradle Markers
- (5) 10' Inlaid Pavement Markings

Only one type of snowplowable delineation will be allowed on a single project.

Materials

Refer to Division 10 of the *Standard Specifications*.

Item	Section
Epoxy	1081
Pavement Markings	1087
Snowplowable Pavement Markers	1086-3

Any snowplowable pavement delineation shall conform to the applicable requirements of Sections 1086, 1087, and 1081 of the *Standards and Specifications*. Use snowplowable delineation markers and markings listed on the NCDOT APL. Any treatment that requires pavement cutting or milling shall be installed within 7 calendar days of the pavement cutting or milling operation.

Construction Methods**(A) General**

For any snowplowable delineation, prior to installation, by brushing, blow cleaning, vacuuming or other suitable means, ensure that all materials and the pavement surface are free of dirt, grease, dust, oil, moisture, mud, grass, or any other material that would prevent adhesion to the pavement by brushing blow cleaning, or vacuuming. If required, apply a primer per manufactures recommendations to pavement surfaces before applying pavement marking material.

Install snowplowable delineation per manufacturers specifications every 80 feet. Make sure pavement markers are oriented to traffic correctly and pavement markings are applied in a uniform thickness. Do not apply markings over longitudinal joints. Protect the pavement markings until they are tack free. Apply applicable Sections 1205 and 1250 of the *Standards Specifications*.

If damage occurs during installation the effected treatments shall be corrected or replaced. This work shall be considered incidental to the installation of the marking or marker.

(B) Polycarbonate H-shaped Markers and Inlaid Cradle Markers

Bond marker housings to the pavement with epoxy adhesive. Mechanically mix and dispense epoxy adhesives as required by the manufacturer's specifications. Place the markers immediately after the adhesive has been mixed and dispensed.

Install polycarbonate H-shaped markers and inlaid cradle markers castings into slots sawcut into the pavement. Make slots in the pavement to exactly duplicate the shape of the casting of the polycarbonate H-shaped markers and inlaid cradle markers.

If saw cutting, milling, or grooving operations are used, promptly remove all resulting debris from the pavement surface. Install the marker housings within 7 calendar days after saw cutting, milling, or grooving the pavement. Remove and dispose of loose material from the slots by brushing, blow cleaning or vacuuming. Dry the slots before applying the epoxy adhesive. Install polycarbonate H-shaped markers and inlaid cradle markers according to the manufacturer's recommendations.

Protect the polycarbonate H-shaped markers or inlaid cradle markers until the epoxy has initially cured and is track free.

Construct inlaid cradle markers in accordance with the details in the plans and as directed by the Engineer.

(C) Reflector Replacement

The following requirements only apply to polycarbonate H-shaped markers and inlaid cradle markers.

In the event that a reflector is damaged, replace the damaged reflector by using adhesives and methods recommended by the manufacturer of the markers and approved by the Engineer. This work is considered incidental if damage occurs during the initial installation of the marker housings and maintenance of initial polycarbonate H-shaped markers or inlaid cradle markers specified in this section.

If during reflector replacement it is discovered that the housing is missing or broken this will be paid as *Polycarbonate H-shaped Markers* or *Inlaid Cradle Markers*. Missing housings shall be replaced. Broken housings shall be removed and replaced. In both cases the slot for the housings shall be properly prepared prior to installing the new housing; patch the existing marker slots as directed by the Engineer and install the new marker approximately one foot before or after the patch. Removal of broken housings and preparation of slots will be considered incidental to the work of replacing housings.

(D) Inlaid Raised Pavement Markers

Cut groove in accordance with the details in the plans and as directed by the Engineer.

Use adhesive recommended by the manufacturer to install markers into the groove in accordance with Section 1251. The raised pavement markers are incidental to inlaid raised pavement markers.

(E) 10' Rumble Skips

Construct 10' rumble skips on asphalt concrete in accordance with Section 665 for all centerline and shoulder rumble skips, details in the plans and as directed by the Engineer. Construct 10' rumble skips on Portland cement concrete in accordance with Section 730 for all centerline and shoulder rumble skips, details in the plans and as directed by the Engineer. The milled rumble strips are incidental to the rumble skips. Using polyurea or extruded 90 mil thermoplastic construct pavement markings in accordance with Section 1205.

(F) 10' Inlaid Pavement Markings

The groove in which the marking is to be placed shall be one inch wider than the marking to be placed and 10 mils deeper than the thickness of the marking.

When using this method, use enhanced reflective media. The following retroreflectivity values shall be met.

MINIMUM INITIAL REFLECTOMETER READINGS		
Item	Color	Reflectivity
Enhanced Reflectivity Media	White	450 mcd/lux/m ²
	Yellow	350 mcd/lux/m ²

Using polyurea, extruded 90 mil thermoplastic or cold applied plastic construct pavement markings in accordance with Section 1205.

Maintenance

Maintain all installed snowplowable delineation before acceptance by the Engineer.

Measurement and Payment

Polycarbonate H-shaped Markers will be measured and paid as the actual number of polycarbonate H-shaped markers satisfactorily placed and accepted by the Engineer.

Inlaid Raised Pavement Markers will be measured and paid as the actual number of inlaid raised pavement markers satisfactorily placed and accepted by the Engineer.

10' Rumble Skips will be measured and paid as the actual number of rumble skips satisfactorily placed and accepted by the Engineer.

Inlaid Cradle Markers will be measured and paid as the actual number of pavement markers satisfactorily placed and accepted by the Engineer.

10' Inlaid Pavement Markings will be measured and paid as the actual number of 10' inlaid pavement markings satisfactorily placed and accepted by the Engineer.

Replace Snowplowable Pavement Marker Reflector will be measured and paid in accordance with Article 1253-5.

Payment will be made under:

Pay Item	Pay Unit
Polycarbonate H-shaped Markers	Each
Inlaid Raised Pavement Markers	Each
10' Rumble Skips	Each
Inlaid Cradle Markers	Each
10' Inlaid Pavement Markings	Each

Division 4 prefers Polycarbonate H-shaped Markers, however, with the approval of the Engineer, an optional marker can be installed if the preferred markers are not available.



DocuSigned by:

Matthew V. Springer, PE

BC60F6E8B584403...
07/12/2023

INTEGRATED MULTIPOLYMER (IMP) PAVEMENT MARKING:

(7-12-23)

Description

This work consists of applying Integrated Multipolymer (IMP) pavement marking to all road surfaces using standard thermoplastic application equipment. A primer shall be used for concrete and any aged asphalt surfaces as required by the Engineer. Retroreflectivity shall be obtained through intermix and drop-on reflective media. Both intermix and drop-on reflective media are required.

Materials

IMP pavement marking material shall conform to the applicable requirements of Section 1087 of the *Standard Specifications*. The installer shall use an integrated multipolymer listed in the NCDOT APL.

Construction Methods

(A) Surface Preparation

Remove any existing pavement markings and remove any material that would prevent the IMP pavement markings from bonding correctly. Use a removal method approved by the Engineer. On concrete surfaces and any aged asphalt surfaces required by the Engineer, apply a primer in accordance with manufacturer's recommendation. Protect primer from traffic until dry to a slightly tacky state before application of IMP. Premarking will be incidental to other items in the contract. Unless directed by the Engineer, there will be no direct payment for interim paint.

(B) Application

Material preparation and application temperatures should be in accordance with manufacturer's specification. Do not apply when the temperatures are at or near the dew point. Apply a test strip to determine if the surface is dry enough if there has been rain in the last 24

hours. Only apply markings to dry clean surfaces. Apply pavement markings using the specifications found in Section 1205-3 of the *Standard Specifications*. Equipment, weather and seasonal limitations, application, and observation period shall be in accordance with Article 1205-4 of the *Standard Specifications*. For minimum initial retroreflectivity requirements, see the chart below.

MINIMUM RETROEFLECTIVITY REQUIRMENTS FOR INTEGRATED MULTIPOLYMER	
Color	Reflectivity
White	425 mcd/lux/m ²
Yellow	325 mcd/lux/m ²

(C) Dry Time

Ensure installed material is track free in accordance with the manufacturer’s recommendations before exposing to traffic.

Measurement and Payment

Integrated Multipolymer Pavement Marking Line, ___ " Width, ___mils Thick will be measured and paid as the actual number of linear feet of pavement marking lines satisfactorily placed and accepted by the Engineer. The quantity of solid lines will be the summation of the linear feet of solid line measured end-to-end of the line. The quantity of skip or broken lines will be the summation of the linear feet derived by multiplying the nominal length of a line by the number of marking lines satisfactorily placed.

Integrated Multipolymer Pavement Marking Characters and Integrated Multipolymer Pavement Marking Symbols will be paid as the actual number of symbols and characters satisfactorily placed and accepted by the Engineer.

Such prices and payment will be full compensation for all work covered by this section including, but not limited to, furnishing, surface preparation, primer, reapplication of molten pavement marking crossed by a vehicle, and removal of all pavement marking materials spilled on the roadway surface.

Payment will be made under:

Pay Item	Pay Unit
Integrated Multipolymer Pavement Marking Lines, ___", ___ mils	Linear Foot
Integrated Multipolymer Pavement Marking Symbols, ___ mils	Each
Integrated Multipolymer Pavement Marking Characters, ___ mils	Each

PROJECT NO.	SHEET NO.	TOTAL NO.
2026CPT.04.08.10981	1	2

SUMMARY OF QUANTITIES

PROJECT NO	COUNTY	MAP NO	ROUTE	DESCRIPTION	TYP NO	LANES	LANE TYPE	LENGTH	WIDTH	BEGI N MP	END MP	1220000000-E	1297000000-E	1330000000-E	1523000000-E	1575000000-E	1704000000-E	1881000000-E	1881000000-E
												INCIDENTAL STONE BASE	1½" MILLING	INCIDENTAL MILLING	SURFACE COURSE, S9.5C	ASPHALT BINDER FOR PLANT MIX	PATCHING EXISTING PAVEMENT	EDGE LINE SINUSOIDAL MILLED RUMBLE STRIPS (8")	CENTER LINE SINUSOIDAL MILLED RUMBLE STRIPS (18")
												TONS	SY	SY	TONS	TONS	TONS	LF	LF
2026CPT.04.08.10981	Wilson	1	NC-581	FROM WAYNE COUNTY LINE TO SR-1118 SPRINGFIELD SCHOOL ROAD	1	2	2WU	5.940	26	0.000	5.940	48	90,605	5,295	7,920	484	350	62,726	31,363
TOTAL FOR MAP NO. 1								5.940				48	90,605	5,295	7,920	484	350	62,726	31,363
2026CPT.04.08.10981	Wilson	2	NC-581	FROM SR-1118 SPRINGFIELD SCHOOL ROAD TO NASH COUNTY LINE	1	2	2WU	7.230	26	5.940	13.170	54	110,282	4,690	9,687	591	400	76,349	38,174
TOTAL FOR MAP NO. 2								7.230				54	110,282	4,690	9,687	591	400	76,349	38,174
TOTAL FOR PROJ NO. 2026CPT.04.08.10981								13.170				102	200,887	9,985	17,607	1,075	750	139,075	69,537
GRAND TOTAL								13.170				102	200,887	9,985	17,607	1,075	750	139,075	69,537

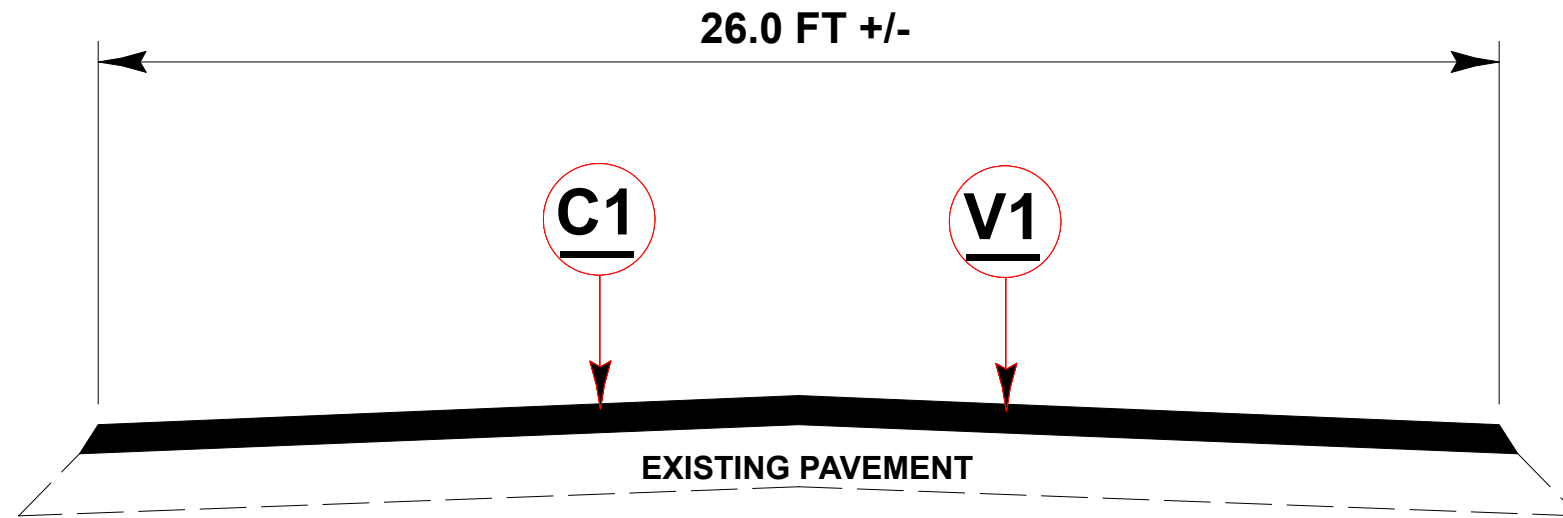

**TYPICAL SECTION # 1
MAP(S) # 1 & 2**

GENERAL NOTES	
1	State Forces Will Be Responsible for Shoulder Reconstruction for All Maps
2	Patching Existing Pavement To Be Completed by Contractor On All Maps

PAVEMENT SCHEDULE	
C1	PROP. APPROX. 1-1/2" ASPHALT CONCRETE SURFACE COURSE, TYPE S9.5C, AT AN AVERAGE RATE OF 168 LBS. PER SQ. YARD
V1	MILL ASHPALT PAVEMENT 1-1/2" DEPTH

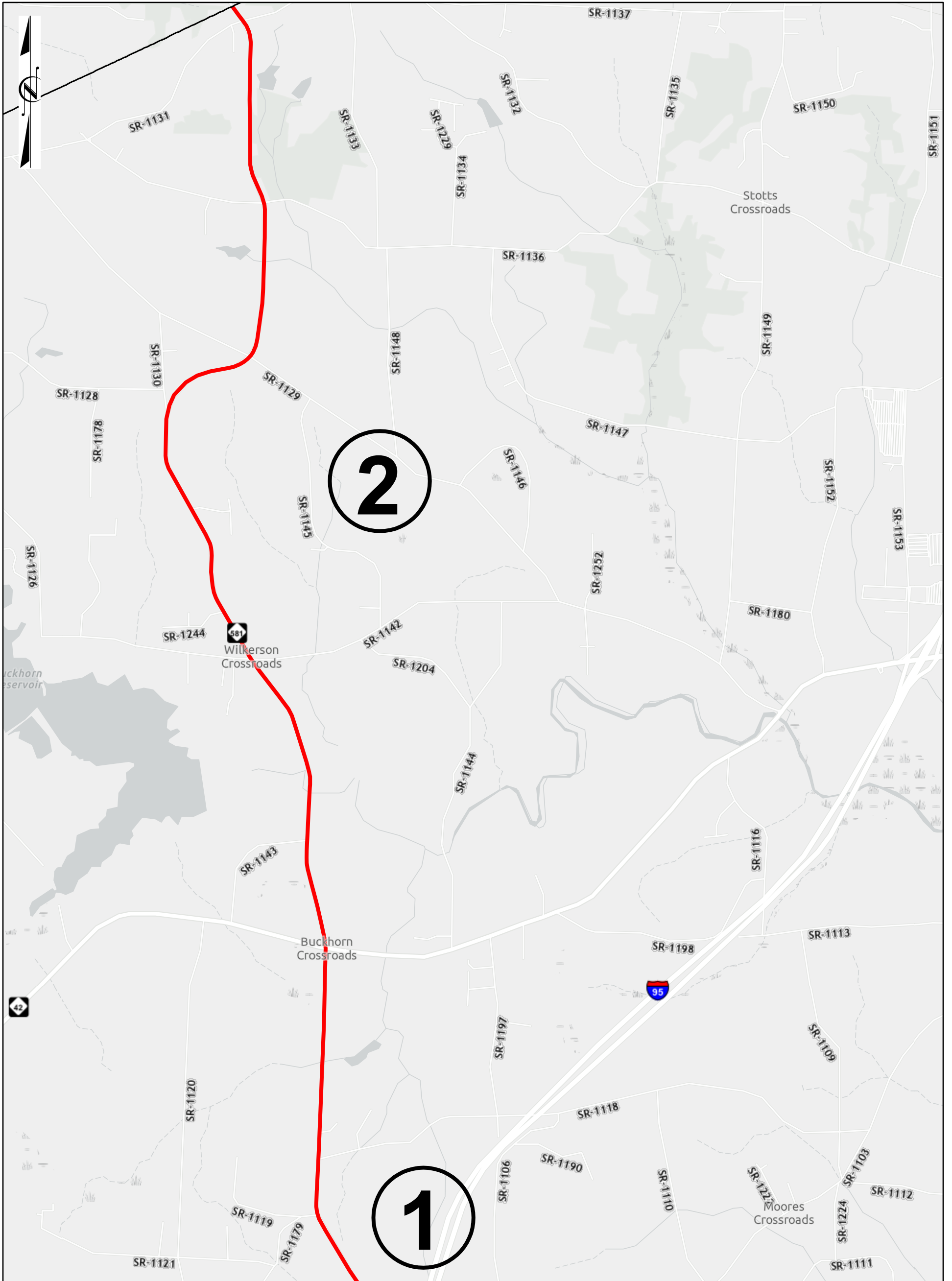

- NOTES:
- 1) DETAIL DOES NOT APPLY TO OGAFc AND ULTRA-THIN BONDED WEARING COURSE.
 - 2) BACKFILL SHOULDER WITH APPROVED MATERIAL.
 - 3) THE SHOULDER WEDGE DEVICE MAY BE DISENGAGED AT PAVED DRIVEWAYS AND SIDE STREETS.

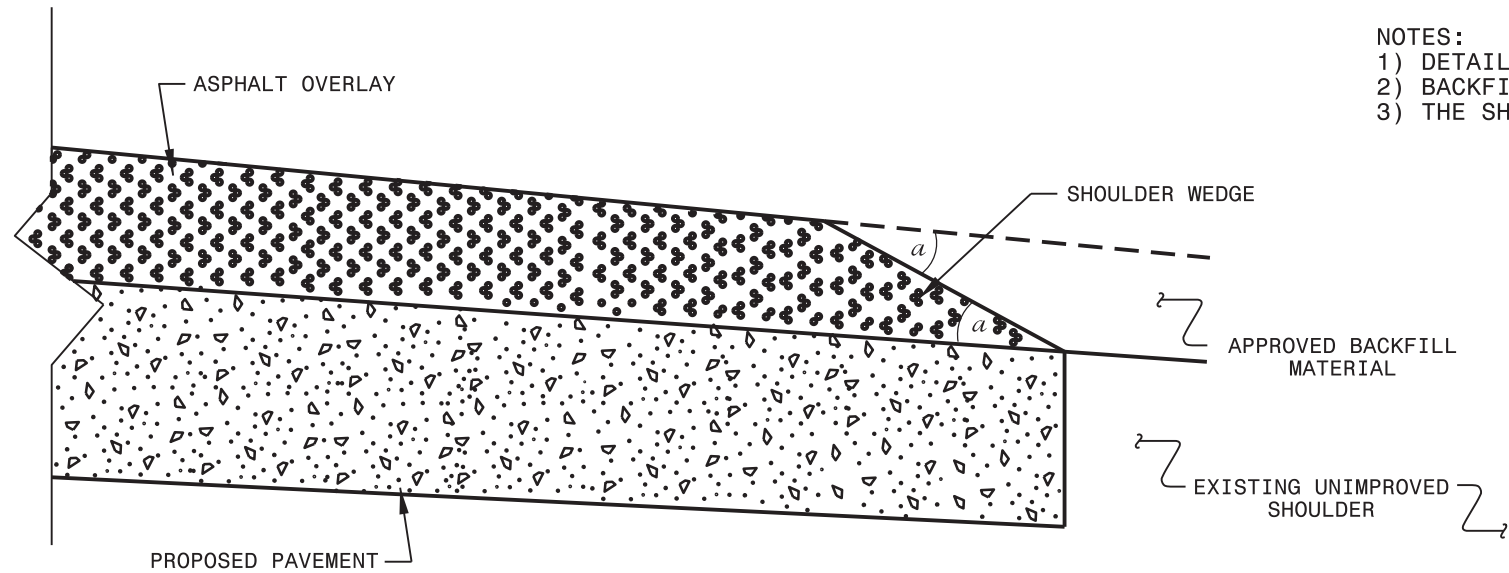

SHOULDER WEDGE DETAIL
 (Resurfacing Projects w/ Widening or
 with Existing Paved Shoulder having no dropoffs)

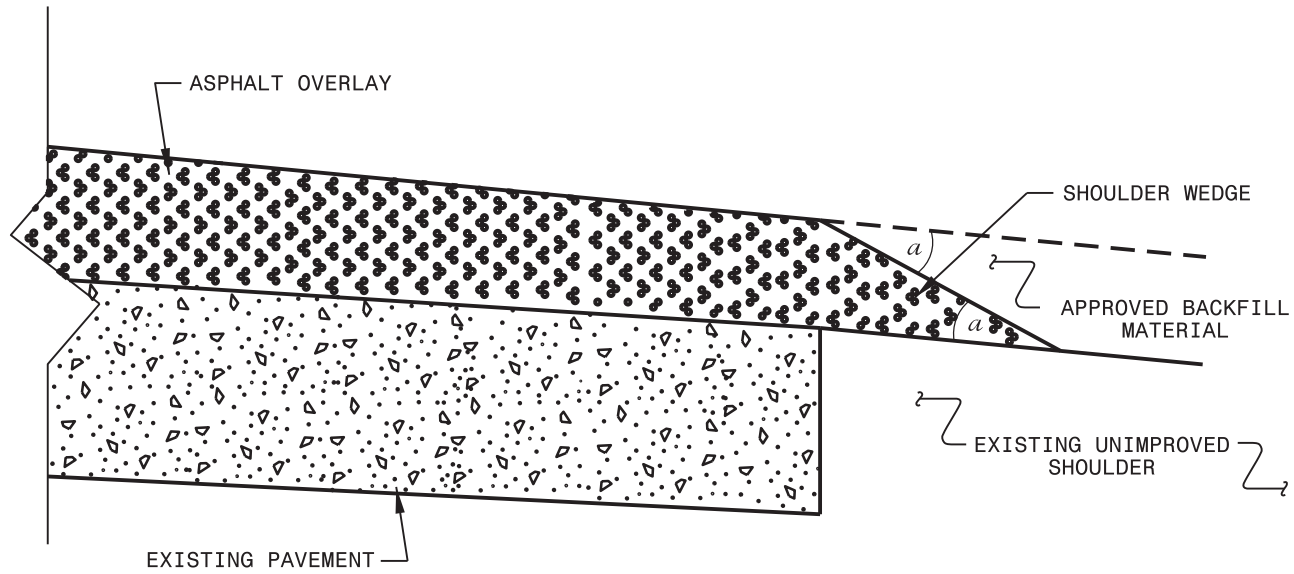

SHOULDER WEDGE DETAIL
 (Resurfacing Projects w/ NO Widening)

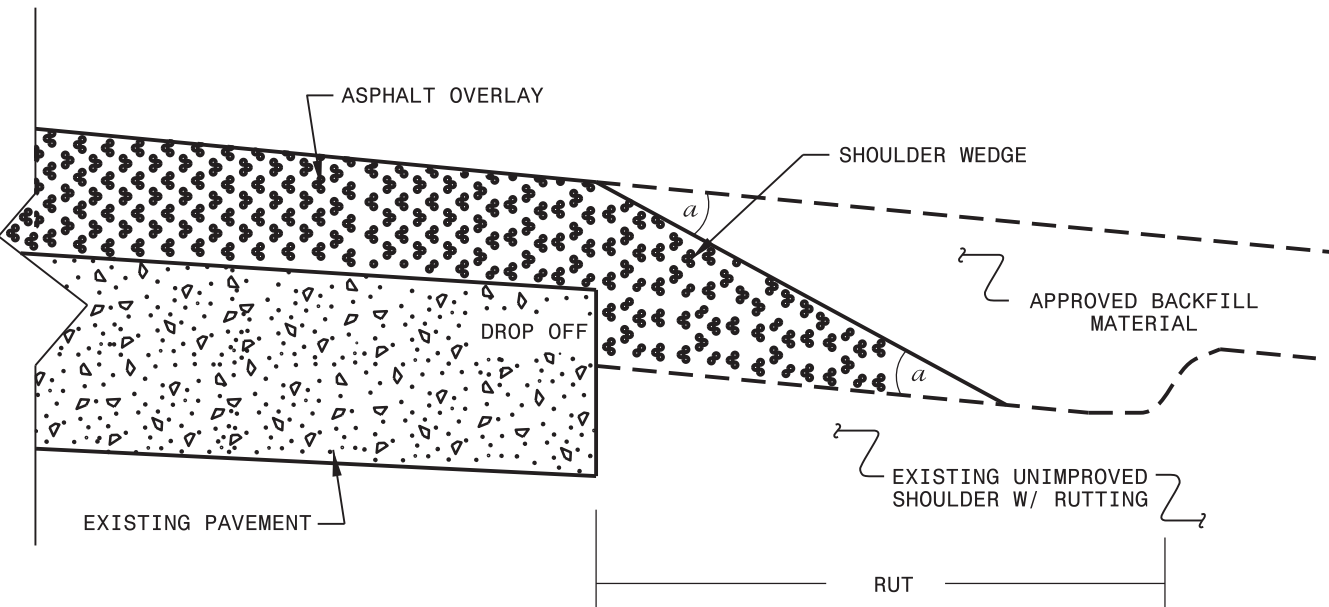

SHOULDER WEDGE DETAIL
 (Resurfacing Adjacent to
 Rutted Shoulder)

- SHOULDER WEDGE ANGLE = 30°

CONTRACT STANDARDS AND DEVELOPMENT UNIT	
Office 919-707-6950	FAX 919-250-4119
SHOULDER WEDGE DETAILS	
ORIGINAL BY: T.SPELL	DATE: 7-19-11
MODIFIED BY:	DATE: 10/16/12
CHECKED BY:	DATE:
FILE SPEC.: susr/details/stand/shoulderwedgedetail.dgn	

SYSTEMS DESIGN USER NAME

DETAILS OF PATCHING EXISTING PAVEMENT PRIOR TO RESURFACING DETAIL

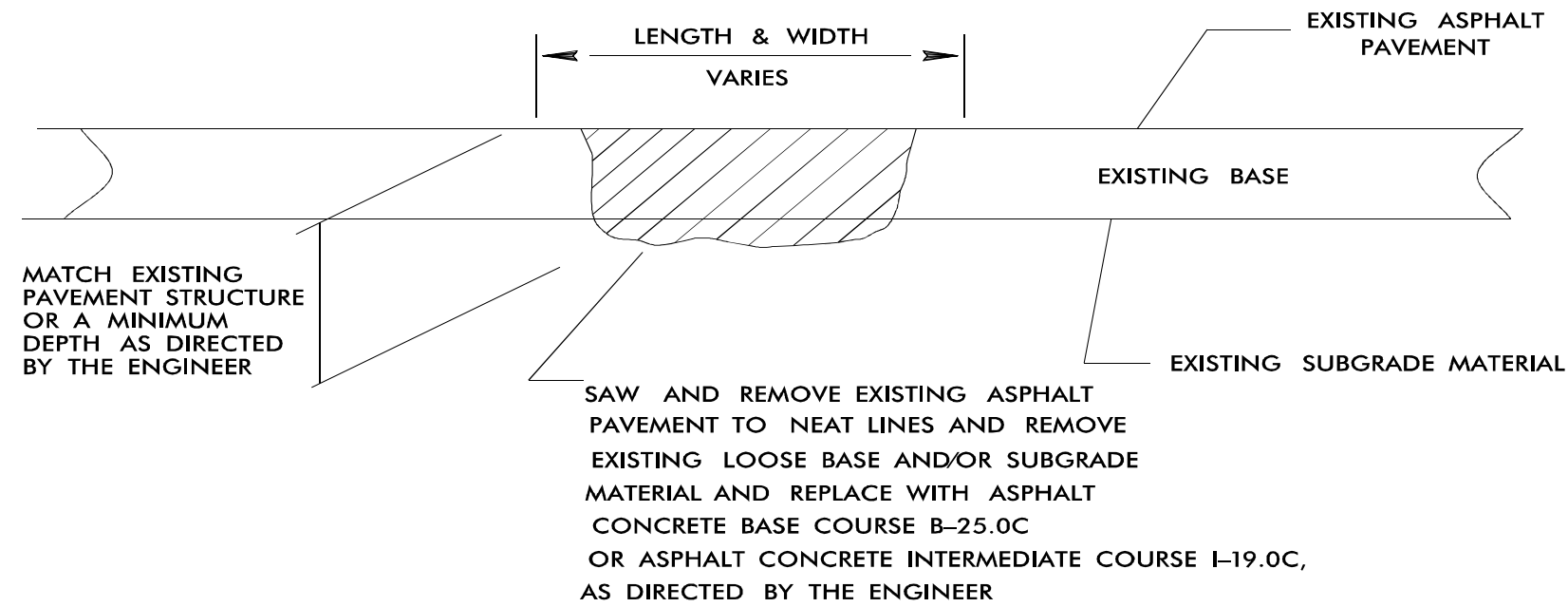

INCIDENTAL MILLING DETAIL

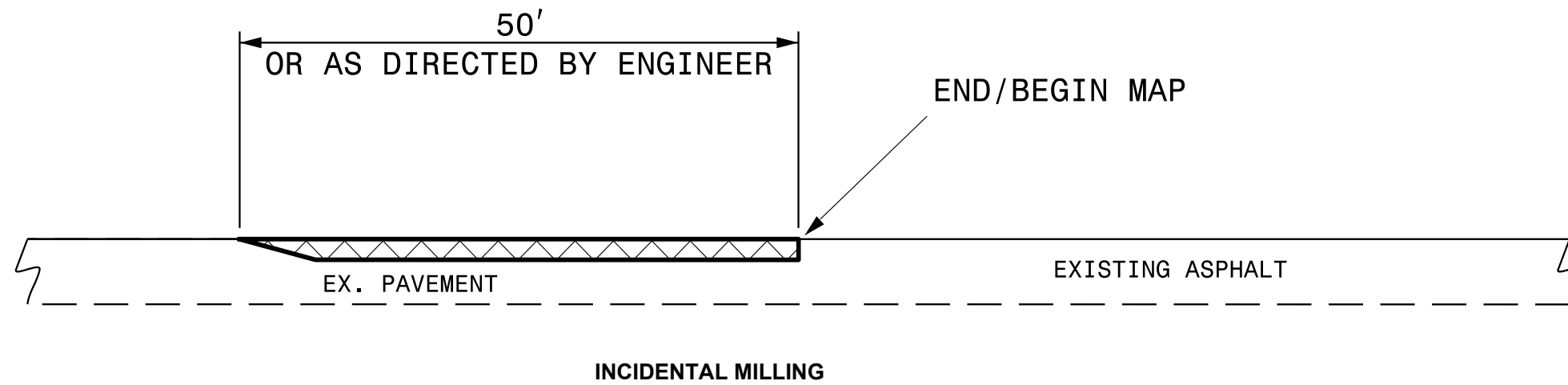

NOTE:

1. PERFORM INCIDENTAL MILLING AT THE TIE INS, RAILROADS, BRIDGE DECKS AND APPROACHES AT THE DIRECTION OF THE ENGINEER.

PROJECT NO.	SHEET NO.	TOTAL SHEETS
2026CPT.04.08.10981	1	1

MAP # 1 INTERSECTION TIE IN LOCATION(S)

ROADWAY NAME	DIRECTION	NOTE
NC Highway 581 @ Nash County Line	Down Station	Complete SR Tie Down at Existing Pavement Joint
NC Highway 581 @ Wayne County Line	Up Station	Complete SR Tie Down at Existing Pavement Joint
SR-1131 New Sandy Hill Church Road	Left of -L-	Complete SR Tie Down at Existing Pavement Joint ; Mill & Patch Existing Ashpalt Island ; Replace with Painted Island
SR-1131 New Sandy Hill Church Road	Right of -L-	Complete SR Tie Down at Existing Pavement Joint
SR-1136 Old Raleigh Road	Left of -L-	Complete SR Tie Down at Existing Pavement Joint ; Mill & Patch Existing Ashpalt Island ; Replace with Painted Island
SR-1136 Old Raleigh Road	Right of -L-	Complete SR Tie Down at Existing Pavement Joint ; Mill & Patch Existing Ashpalt Island ; Replace with Painted Island
SR-1129 Healthy Plains Church Road	Left of -L-	Complete SR Tie Down at Existing Pavement Joint ; Mill & Patch Existing Ashpalt Island ; Replace with Painted Island
SR-1129 Healthy Plains Church Road	Right of -L-	Complete SR Tie Down at Existing Pavement Joint ; Mill & Patch Existing Ashpalt Island ; Replace with Painted Island
SR-1130 Bryd Road	Right of -L-	Complete SR Tie Down at Existing Pavement Joint
SR-1142 Rock Ridge School Road	Left of -L-	Complete SR Tie Down at Existing Pavement Joint
SR-1142 Rock Ridge School Road	Right of -L-	Complete SR Tie Down at Existing Pavement Joint
SR-1143 Renfrow Road	Right of -L-	Complete SR Tie Down at Existing Pavement Joint
NC Highway 42	Down Station	Complete SR Tie Down at Existing Pavement Joint Prior To Stop Sign
NC Highway 42	Up Station	Complete SR Tie Down at Existing Pavement Joint After The Stop Sign

MAP # 2 INTERSECTION TIE IN LOCATION(S)

ROADWAY NAME	DIRECTION	NOTE
NC Highway 581	Down Station	Complete SR Tie Down at Existing Pavement Joint
NC Highway 581	Up Station	Complete SR Tie Down at Existing Pavement Joint
SR-1118 Springfield School Road	Left of -L-	Complete SR Tie Down at Existing Pavement Joint
SR-1179 Watson Grove Church Road	Right of -L-	Complete SR Tie Down at Existing Pavement Joint
SR-1195 Revell Road	Left of -L-	Complete SR Tie Down at Existing Pavement Joint
SR-1195 Revell Road	Right of -L-	Complete SR Tie Down at Existing Pavement Joint ; Mill & Patch Existing Ashpalt Island ; Replace with Painted Island
SR-1100 Saint Marys Church Road	Left of -L-	Complete SR Tie Down at Existing Pavement Joint
SR-1100 Saint Marys Church Road	Right of -L-	Complete SR Tie Down at Existing Pavement Joint
SR-1107 Fannie Road	Left of -L-	Complete SR Tie Down at Existing Pavement Joint
US Highway 301	Down Station	Complete SR Tie Down at Existing Pavement Joint Prior To Stop Sign
US Highway 302	Up Station	Complete SR Tie Down at Existing Pavement Joint After The Stop Sign
RRX Crossing	Down Station	Complete SR Tie Down at Existing Pavement Joint
RRX Crossing	Up Station	Complete SR Tie Down at Existing Pavement Joint
SR-1662 Newsome Mill Road	Left of -L-	Complete SR Tie Down at Existing Pavement Joint ; Mill & Patch Existing Ashpalt Island ; Replace with Painted Island
SR-1665 Kirby Road	Right of -L-	Complete SR Tie Down at Existing Pavement Joint ; Mill & Patch Existing Ashpalt Island ; Replace with Painted Island
SR-1663 Harrel Store Road	Left of -L-	Complete SR Tie Down at Existing Pavement Joint ; Mill & Patch Existing Ashpalt Island ; Replace with Painted Island

PROJECT NO.	SHEET NO.	TOTAL SHEETS
2026CPT.04.08.10981	1	1

BRIDGE TREATMENT LIST						
WBS:	2026CPT.04.08.10981	WBS:	-	COUNTY :	WILSON	
MAP #	ROADWAY TREATMENT	SR # (if applicable)	ROADWAY NAME	STRUCTURE #	BRIDGE SURFACE	STRUCTURE COMMENTS
1	Mill 1.5" & 1.5" S9.5C	-	NC Highway 581	# 0028	Concrete	Mill Approach 1.5" & Pave for Smooth Transition to Bridge Deck ; Do Not Pave Bridge ; Use IMP Pavement Markings on Bridge Deck
2	Mill 1.5" & 1.5" S9.5C	-	NC Highway 581	# 0015	Concrete	Mill Approach 1.5" & Pave for Smooth Transition to Bridge Deck ; Do Not Pave Bridge ; Use IMP Pavement Markings on Bridge Deck

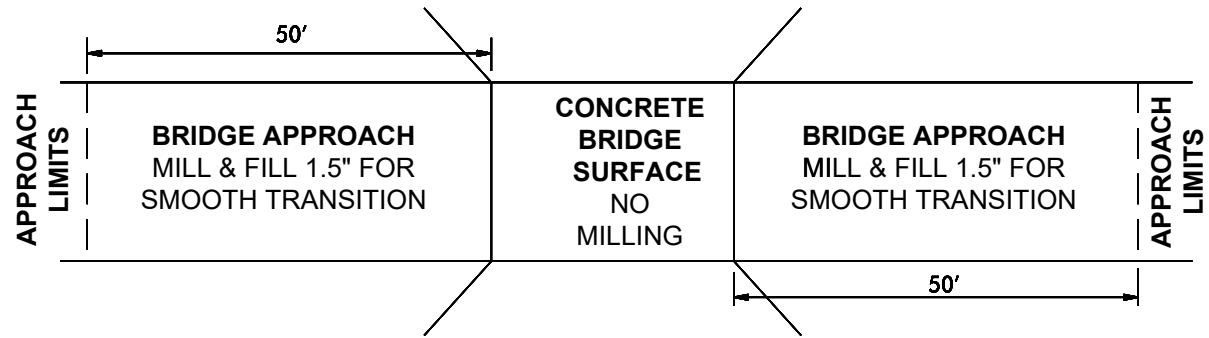

DETAIL FOR MAP # 1 & 2 / STRUCTURE # # 0015 & #0028

TC-1

WORK ZONE TRAFFIC CONTROL GENERAL REQUIREMENTS

TEMPORARY TRAFFIC CONTROL (TTC):

(7-16-13) (12-08-20) (02-18-21) (11-13-23) (03-27-24) (12-17-2024)

RWZ-1

Maintain traffic in accordance with Divisions 10, 11 and 12 of the *Standard Specifications* and the following provisions:

Install Work Zone Advance Warning Signs in accordance with the detail drawing provided in these plans prior to beginning any other work. Use a lane closure or slow moving operation to complete the work, as necessary, unless otherwise indicated. Refer to Standard Drawing No. 1101.02, 1101.11, 1110.01, 1110.02, 1130.01, 1135.01 and 1180.01 of the *NCDOT Roadway Standard Drawings*. Use a moving operation only if the minimum speed maintained at all times is 3 mph with no stops that narrow or close a lane of travel. If the moving operation is progressing slower than 3 mph at any time, install a lane closure. Maintain the existing traffic pattern at all times, except in the immediate work zone where lane closures are allowed as determined by the Engineer. If applicable, maintain existing pedestrian facilities in accordance with *Pedestrian Accommodation at Curb Ramp Work Locations*, found elsewhere in this Contract.

Refer to attached details and Standard Drawing No. 1101.02, 1101.03, 1101.04, 1101.05, 1101.11, 1110.01, 1110.02, 1115.01, 1130.01, 1135.01, 1145.01, 1150.01, 1165.01, and 1180.01 of the *NCDOT Roadway Standard Drawings* when closing a lane of travel in a stationary work zone such as pavement patching, resurfacing, curb ramp work, or pavement marking removal. Properly ballasted cones and skinny drums may be used instead of drums. However, drums are required for the upstream taper portion of lane closures in all applications. The stationary work zone shall be a maximum of 1 mile in length at any given time on 2 lane, 2 way facilities unless otherwise approved by the Engineer. A pilot vehicle operation may be used in conjunction with flaggers and the appropriate pilot vehicle warning signing as directed by the Engineer. At the discretion of the Contractor, automated flagging assistance devices (AFAD) or portable traffic signals (PTS) may be used to assist, supplement, or replace human flaggers in accordance with the *Flaggers* provision found elsewhere in this contract.

During periods of construction inactivity, return the traffic pattern to the existing alignment and remove or cover any work zone signs. When covering work zone signs, use an opaque material that prevents reading of the sign at night by a driver using high beam headlights. Use material which does not damage the sign sheeting. Replace any obliterated markings as required by other sections of the *Standard Specifications* and the Engineer.

When personnel and/or equipment are working within 5 feet of an open travel lane, close the nearest open travel lane using Standard Drawing No. 1101.02 of the *NCDOT Roadway Standard Drawings*.

TC-2

When personnel and/or equipment are working within a lane of travel, close the lane according to the traffic control plans, Standard Drawing No. 1101.02 of the *NCDOT Roadway Standard Drawings* or as directed by the Engineer. Conduct the work so that all personnel and/or equipment remain within the closed travel lane.

Do not work simultaneously, on both sides of an open travel way, within the same location, on a two-lane, two-way road. Perform work only when weather and visibility conditions allow safe operations as directed by the Engineer.

When utilizing a slow-moving operation for such items as pavement marking and marker placement, the operation shall consist of the vehicles and devices as shown on Standard Drawing No. 1101.02, Sheet 14 or 15, of the *NCDOT Roadway Standard Drawings*. Traffic cones may be used when necessary to provide additional protection of wet pavement markings. Ballast all traffic cones so they will not be blown over by traffic.

PAVING OPERATIONS:

1) Paving Lift Requirements and Time Limitations:

For paving lifts of 2 inches or less, bring all newly resurfaced lanes to the same station and elevation within 72 hours. If not brought up to the same station and elevation within 72 hours, the Contractor shall place portable UNEVEN PAVEMENT signs in advance of the uneven pavement and spaced every ½ mile along the section of uneven pavement. Once mitigated, all portable UNEVEN PAVEMENT signs shall be removed. No additional compensation will be made for these signs or any other type of portable warning signs as these are included as part of the *Temporary Traffic Control* contract pay item.

For paving lifts greater than 2 inches, bring all newly resurfaced lanes to the same station and elevation by the end of each work day unless the Contractor utilizes the notched wedge paving methods as described below.

Failure to comply with the following requirements will result in a suspension of all other operations until all lanes of traffic are brought to the same station and elevation:

1. During paving operations, any paving lift greater than 2 inches for asphalt surface course mixes shall be mitigated by having an approved wedge apparatus on the paver that shapes the edge 1 inch vertically and the remaining at a maximum slope steepness of 2:1. For intermediate and base course mixes, use an approved wedge device that shapes the edge with a maximum slope steepness of 2:1. The maximum paving lift allowed to use this method is 3 inches.

TC-3

2. At the end of the work day, the Contractor shall place portable UNEVEN PAVEMENT signs in advance of the uneven pavement and spaced every $\frac{1}{2}$ mile along the section of uneven pavement. Once mitigated, all portable UNEVEN PAVEMENT signs shall be removed. No additional compensation will be made for these signs or any other type of portable warning signs as these are included as part of the *Temporary Traffic Control* contract pay item.
3. In the next day's paving operation and not to exceed 72 hours, the Contractor shall bring up the adjacent lane to the same station and elevation before any further paving takes place on the project.

2) Asphalt Surface Treatments (AST)

For AST Operations, there is no drop-off condition to be signed. Stationary LOOSE GRAVEL and UNMARKED PAVEMENT signs shall replace LOW/SOFT SHOULDER signs. For placement and spacing of these signs, see the Signing Detail Sheet. All other advance warning signs are to be portable mounted. These signs are included as part of the *Temporary Traffic Control* contract pay item.

3) Fine Milling/Microsurfacing (Depths less than 1 inch)

For fine milling operations less than 1 inch, paving is not required in the same work period. The paving of the fine milled area is to be conducted within the next work period and not to exceed 72 hours. No advance warning signs are necessary for these conditions unless the paving operations exceed 72 hours. If this occurs, install portable UNMARKED PAVEMENT signs. These signs are incidental to the other items of work included as part of the *Temporary Traffic Control* contract pay item.

4) Shoulder Drop-Off Requirements

Whenever paving operations create an edge of pavement drop-off greater than 2 inches, within 72 hours, the Contractor shall backfill at a 6:1 slope from the edge and finished elevation of the pavement that has an edge of pavement drop-off as follows:

- (A) Drop-off that exceeds 2 inches on roadways with posted speed limits of 45 mph or greater.
- (B) Drop-off that exceeds 3 inches on roadways with posted speed limits less than 45 mph.

Backfill the edge of pavement drop-off with suitable compacted material, as approved by the Engineer. The material, equipment and labor associated with this operation will be paid as *Aggregate Shoulder Borrow* or *Borrow Excavation* in accordance with the *Shoulder Reconstruction Per Shoulder Mile* special provision found elsewhere in the contract. If the

TC-4

Shoulder Reconstruction Per Shoulder Mile special provision is not included in the contract, the work of pavement drop-off repair as described above will be paid as extra work in accordance with Article 104-7.

PROJECT REQUIREMENTS:

Failure to comply with the following requirements will result in a suspension of all other operations:

1. Before working on ANY MAP, the Contractor shall submit a written construction sequence for traffic control and construction lighting for ALL MAPS to the Engineer at the first pre-construction meeting and the sequence must be approved before closing a lane of traffic. If applicable, the Contractor shall also submit a description of how pedestrian access will be maintained during any curb ramp work. Refer to *Pedestrian Accommodation at Curb Ramp Work Locations*, found elsewhere in this Contract, for pedestrian maintenance requirements.
2. The temporary use of portable concrete barrier and the need for any long-term temporary traffic patterns are not anticipated and are not covered by this provision. If the Engineer determines there is a need, then coordinate with the Work Zone Traffic Control Section at 919-814-5000.
3. Obtain written approval of the Engineer before working in more than one location or setting up additional lane closures. The maximum length of any one lane closure is 1 mile unless otherwise directed by the Engineer.
4. If Lane Closure Restrictions apply, see Intermediate Contract Times and Liquidated Damages special provision.
5. Contractor shall mill and pave lanes in an order such that water shall not accumulate.
6. Traffic Control for the milling and/or paving of ramps is to be done according to Standard Drawing No 1101.02, Sheets 10 & 11, unless otherwise approved to be closed by the Engineer. If approved, Contractor will provide plans and devices for the detour according to Standard Drawing No 1101.02, Sheets 12 & 13, at no additional cost to the department.
7. If milled areas are not paved back within 72 hours, the Contractor is to furnish and install portable signs to warn drivers of the conditions. These are to include, but not limited to ROUGH ROAD (W8-8), UNEVEN LANES (W8-11), and GROOVED PAVEMENT (W8-15) w/ Motorcycle Plaque mounted below. These are to be dual indicated on Multi-Lane Roadways with speed limits of 45 mph and greater where lateral clearance can be obtained within the median areas. These portable signs are incidental to the other items of work

TC-5

included as part of the *Temporary Traffic Control* contract pay item.

WORK ZONE SIGNING:

Description

Install advance/general warning work zone signs according to the Detail Drawing provided in these plans prior to beginning of work. Install and maintain signing in accordance with the attached drawings and Divisions 11 and 12 of the *Standard Specifications*.

(A) Installation

All stationary Advance/General warning work zone signs require notification to existing Utility owners per Article 105-8 of the *Standard Specifications* within 3 to 12 full working days prior to installation.

Install Advance/General warning work zone signs before beginning work on a particular map. If signs are installed more than 7 calendar days prior to the beginning of work on a particular map, cover the signs until the work begins. Install each work zone Advance/General warning sign separately and not on the same post or stand with any other sign except where an advisory speed plate or directional arrow is used.

All stationary signing is to be installed as shown on the detail drawing(s) unless otherwise directed by the Engineer. The signs as shown on the detail drawing(s) are all that are required for a contractor to begin a resurfacing contract. Any additional signs requested by the Engineer shall be installed within 7 business days of the start of contract work. All sign locations are to be verified by the Engineer prior to installation. Once the signs have been installed and accepted, any sign relocations requested by the Department will be compensated in accordance with Article 104-7. Any additional signs other than the ones shown in the drawing will be compensated in accordance with Article 104-7.

No stationary -Y- Line advance warning signage is required unless there is more than 1,000 feet of resurfacing along the -Y- line. Whenever work proceeds through an intersection, portable signs shall be used for traffic control. There will be no direct compensation for any portable signing.

If there is a period of construction inactivity longer than 14 calendar days, remove or cover advance/general warning work zone signs. Uncover advance/general warning work zone signs no more than 7 calendar days before work resumes. All other operations may be suspended upon failure to comply with the above requirements. Such suspended operations would not be resumed until the above requirements are fulfilled.

TC-6

(B) Sign Removal

Once Maps on the Project are substantially complete, it is acceptable practice to remove the Stationary Work Zone Signs in lieu of waiting until all of the Maps are completed on the Project. A Map is substantially complete when the resurfacing operations are finished and the shoulders are brought up to the same elevation as the proposed pavement and when pavement markings (paint) are installed along the centerline and edge lines. The final pavement markings (ex. Thermoplastic/Polyurea) or pavement markers (Raised/Snowplowable) do not have to be installed for Maps to be considered substantially complete. Final pavement marking/markers are installed with portable signing according to Standard Drawing 1101.02, Sheets 14 & 15. Any remaining punch list items requiring traffic control are compensated as part of the *Temporary Traffic Control* contract pay item.

Stationary Work Zone Sign removal is a condition of final project acceptance.

(C) Lane Closure Work Zone Signs

Install any required lane closure signing needed during the life of the project in accordance with Standard Drawing No. 1101.02, 1101.11 and 1110.02 of the *NC DOT Roadway Standard Drawings*. Any required portable signs for lane closures are compensated as part of the *Temporary Traffic Control* contract pay item.

MEASUREMENT AND PAYMENT:

Temporary traffic control work, including, but not limited to installation and removal of portable signs, cones, drums, skinny drums, flaggers (including AFAD or PTS units), changeable message boards, truck mounted attenuators, flashing arrow boards, and pilot vehicles for the sole purpose of maintaining vehicular traffic will be paid at the contract lump sum price for *Temporary Traffic Control*.

The *Temporary Traffic Control* pay item does not include work zone advance or general warning signs.

The *Temporary Traffic Control* pay item does not include Pedestrian Channelizing Devices and applicable signs, Audible Warning Devices, Temporary Curb Ramps, or a Pedestrian Transport Service required for the sole purpose of maintaining pedestrian movements. Refer to *Pedestrian Accommodation at Curb Ramp Work Locations*, found elsewhere in this Contract, for measurement and payment information for these items.

Partial payments for *Temporary Traffic Control* will be made as follows: The cumulative total of the lump sum price for temporary traffic control will be equal to the percent complete (project) as

TC-7

calculated for each partial pay estimate. Additional flashing arrow boards and message boards beyond those shown in the contract, detail drawings or *Roadway Standard Drawings* required by the Engineer will be paid as extra work in accordance with Article 104-7 of the *Standard Specifications*.

The work of satisfactorily installing and removing work zone advance and/or general warning signs, including, but not limited to, furnishing, locating, installing, covering, uncovering and removing stationary signs will be measured for each required sign and paid at the contract price for *Work Zone Advance/General Warning Signing (SF)*. Payment for *Work Zone Advance/General Warning Signing* will be limited to a maximum of 90% of the total installed quantity. The remaining 10% will be paid once all signs have been removed.

The Lump Sum price for *Temporary Traffic Control* will include the work of 4 flaggers (including AFAD or PTS units) per operation per map being utilized at the same time on any day. If a pilot vehicle is used for an operation, the Lump Sum Price for *Temporary Traffic Control* will include the work of 5 flaggers. The operator of a pilot vehicle will be considered one of the 5 flaggers.

Any additional flagging beyond the included amount covered in the *Temporary Traffic Control* pay item will be considered supplemental flagging and compensated at a rate of \$35.00 per hour for each additional flagger (including AFAD or PTS units) as approved by the Engineer. The minimum measurement for each additional flagger will be 4 hours, even if the actual additional flagger hours are less than 4 hours.

Payment will be made under:

Pay Item	Pay Unit
Temporary Traffic Control	Lump Sum
Work Zone Advance/General Warning Signing	Square Foot

TC-8

RESURFACING OPERATIONS:

(7-15-14) (11-13-23) (10-14-24)

RWZ-2

Coordinate the installation of items required by the contract documents and resurfacing operations such that these operations are completed in the order as agreed upon with the Engineer at the first pre-construction meeting. Refer to the Provisions, Typicals and Details unless otherwise directed by the Engineer.

Notify the Engineer 15 consecutive calendar days before resurfacing a bridge or its approaches. Patch and make repairs to bridge surface and its approaches before resurfacing occurs. Coordinate all operations on the bridge and its approaches with the Engineer.

Notify the Engineer 48 hours before resurfacing the areas of existing pavement that require patching. Patch these areas before resurfacing occurs. Allow full depth asphalt patching to cool to the point of supporting traffic without displacement or rutting before reopening closed lane. Coordinate the resurfacing operations of the patched areas with the Engineer.

Notify the Engineer 48 hours before milling or resurfacing will interfere with the existing Signal Loops. Loops may need to be placed in milled surface before resurfacing occurs. Coordinate all signal loop operations with the Engineer.

For partial or wheel track milling operations on two-way, two-lane facilities, mill and pave back by the end of each work day. For Partial or wheel track milling operation on multi-lane facilities, the lane being milled may be left closed and paved back within 72 hours.

The following options are available during Resurfacing and milling operations on two-way, two-lane facilities when the entire roadway or entire lane is to be milled:

- (A) Mill a single lane and pave back by the end of each work day.
- (B) Mill the entire width of roadway and pave back within 72 hours.

The following options are available during Resurfacing and milling operations on multi-lane facilities when all lanes or a single lane in one direction are to be milled:

- (A) Mill a single lane and pave back by the end of each work day.
- (B) Mill the entire width of pavement for all lanes to be milled in any direction daily and pave back within 72 hours.

Slope the pavement at the beginning and end of the daily milling operation as directed by the Engineer. Sweep and remove all milled material from the roadway as soon as the daily milling operation is completed. Continue milling operations until the section of roadway being milled is complete. Remove any existing pavement adjacent to the milled area that has been damaged and replace it with patch material as directed by the Engineer.

Operate equipment and conduct operations in the same direction as the flow of traffic. Maintain vehicular access in accordance with Section 1101-05 of the *Standard Specifications* using suitable backfill material approved by the Engineer.

TC-9

Provide appropriate lighting in accordance with Section 1413 of the *Standard Specifications*.

Milled Rumble Strips

When utilized, milled rumble strips shall be installed in accordance with the contract.

TC-10

PAVEMENT MARKINGS AND MARKERS:

(7-15-14) (11-13-23) (10-14-24)

RWZ-3

Markings: All Facilities

Pavement markings shall be installed in accordance with Standard Drawings 1205.01 through 1205.15 of the *Roadway Standard Drawings* and Section 1205 of the *Standard Specifications* with the exception of the following changes underlined in Table 1205-1 in Subarticle 1205-3(D):

(D) TIME LIMITATIONS FOR REPLACEMENT

TABLE 1205-1 TIME LIMITATIONS FOR REPLACEMENT		
Facility Type	Marking Type	Replacement Deadline
Full-control-of-access multi-lane roadway (4 or more total lanes) and ramps, including Interstates	All markings	By the end of each workday's operation if the lane is opened to traffic
Multi-lane roadways (3 or more lanes) and ramps	Center Line, Lane Line, Railroad symbols, Stop bars, school symbols and <u>crosswalk markings</u>	By the end of each workday's operation if the lane is opened to traffic (temporary paint with beads may be used)
	Edge Lines, gore lines and all other symbols	By the end of the 3rd calendar day after obliteration
Two-lane, two-way roadways	All centerline markings, railroad, Stop bars, school symbols and <u>crosswalk markings</u>	By the end of the 5th calendar day after obliteration
	Edge Lines and all other symbols	By the end of the <u>30th</u> calendar day after obliteration

Prior to placing pavement marking material on concrete surfaces that are diamond ground, use an acceptable method to grind ridges smooth only where pavement marking will be installed.

Type 3 Cold Applied Plastic may be used in lieu of Type 2 Cold Applied Plastic. If Type 3 Cold Applied Plastic is used, it shall be paid for using the Type 2 Cold Applied Plastic pay item.

TC-11

Unless otherwise specified, Heated-in-Place Thermoplastic may be used in lieu of Extruded Thermoplastic for stop bars, symbols, characters and diagonals. If Heated-in-Place Thermoplastic is used, it shall be paid for using the Extruded Thermoplastic pay item.

Unless otherwise specified, Heated-in-Place Thermoplastic may be used in lieu of Cold Applied Plastic for stop bars, symbols, characters and diagonals on asphalt or concrete roadways. If Heated-in-Place Thermoplastic is used, it shall be paid for using the Cold Applied Plastic pay item.

Markers: All Facilities

Remove existing pavement markers in preparation for paving. Repair any pavement damage due to existing pavement marker removal prior to the end of the work day. Dispose of existing pavement markers as directed by the Engineer. No direct payment will be made for this work as it will be incidental to the paving operation.

Install permanent pavement markers within 60 calendar days after completing the resurfacing on each map. Pavement markers shall be installed in accordance with the contract.

Markings and Markers: All Facilities

Review and record the existing pavement markings and markers before resurfacing. Re-establish the new pavement markings and markers using the record of existing markings in conjunction with the contract. Unless otherwise directed by the Engineer, new pavement markings and markers not meeting the current standards should be updated as specified in the contract. Have existing or proposed passing zones reviewed by the engineer before installation. Submit the record of the existing pavement markings seven calendar days before the obliteration of any pavement markings.

Mainline pavement shall not be left milled, unmarked or uneven at the end of a paving season. If the Contractor begins any map and does not complete within the seasonal restrictions, including placement of final pavement markings or permanent markers, the Contractor shall be responsible for, at his expense, Paint in accordance with Article 1205-08 and Temporary Markers in accordance with Section 1251 of the *Standard Specifications*.

SIGNING FOR RESURFACING PROJECTS

LEGEND
 ┆ STATIONARY SIGN
 ← DIRECTION OF TRAFFIC FLOW

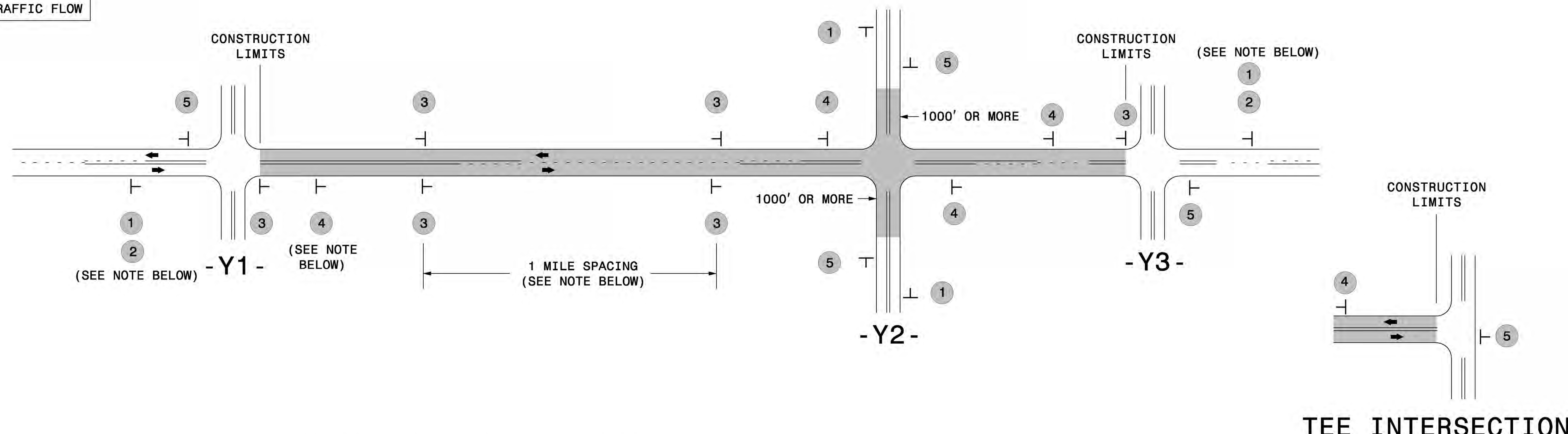

MAINLINE (-L-) SIGNING

-Y- LINE SIGNING

SIGNING NOTES AND PLACEMENT PER DIRECTION	1		PLACE 1000' PRIOR TO BEGINNING OF CONSTRUCTION LIMITS. ONLY USED ON -Y- LINES IF RESURFACING LIMITS EXTEND 1000' ALONG -Y- LINE.	<p>NO REQUIRED STATIONARY SIGNING FOR THE FOLLOWING -Y- LINE CONDITIONS:</p> <ol style="list-style-type: none"> 1) LESS THAN 1000' OF RESURFACING ALONG -Y- LINE 2) SUBDIVISION ROADS 3) DEAD END ROADS <p>WHEN PAVING/CONSTRUCTION ACTIVITIES PROCEED ACROSS AN UNSIGNED -Y- LINE, PORTABLE ADVANCE WARNING SIGNS SHALL BE USED ALONG THE -Y- LINE AS SHOWN BELOW. REMOVE UPON COMPLETION OF WORK.</p> <div style="display: flex; justify-content: space-around;"> <div style="text-align: center;"> PLACED 500' IN ADVANCE OF FLAGGER. </div> <div style="text-align: center;"> PLACED 250' IN ADVANCE OF FLAGGER. </div> </div>
	2		#2 SIGN ONLY USED WHEN CONSTRUCTION LIMITS ARE 2 OR MORE MILES IN LENGTH. ROUND UP TO NEXT WHOLE NUMBER. (NO FRACTIONAL OR DECIMAL NUMBERS)	
	3		- PLACE INITIALLY AT THE CONSTRUCTION LIMITS AND SPACE 1 MILE APART THEREAFTER. - AT TEE INTERSECTIONS INSTALL INITIALLY 1/2 MILE FROM INTERSECTION AND SPACE 1 MILE APART THEREAFTER.	
	4		- THESE ARE FOR -Y- LINES THAT ARE "THROUGH" ROADWAYS. - DEAD END AND SUBDIVISION ROADS ARE NOT "THROUGH" ROADWAYS. - INSTALL 500' +/- FROM EACH -Y- LINE APPROACH AS SHOWN ABOVE. - FOR MULTIPLE -Y- LINES THAT ARE SEPARATED BY 0.25 MILES OR LESS, TREAT AS A SINGLE UNIT AND INSTALL WITHIN 500' OF EACH APPROACH. - A MAXIMUM OF 2 SIGN SETS PER MILE. DO NOT INSTALL WHEN -Y- LINES ARE WITHIN 0.5 MILES FROM "END ROAD WORK" SIGN. - FOR TEE INTERSECTIONS, INSTALL WITHIN 500' +/- OF THE INTERSECTION ALONG -L- LINE.	
	5		PLACE 500' FOLLOWING THE END OF CONSTRUCTION LIMITS OR AS SHOWN WHEN WORK ENDS AT A 3-WAY TEE INTERSECTION.	

THE ABOVE SIGNS ARE ALL THAT ARE REQUIRED FOR A CONTRACTOR TO BEGIN A RESURFACING CONTRACT. ANY ADDITIONAL SIGNS REQUESTED BY NCDOT DIVISIONS SHALL BE INSTALLED WITHIN 7 BUSINESS DAYS OF THE START OF CONTRACT WORK.

MAPS LESS THAN 2 MILES

FOR RESURFACING MAPS WITH CONSTRUCTION LIMITS LESS THAN 2 MILES IN LENGTH, NO STATIONARY SIGNS ARE REQUIRED. USE PORTABLE "ROAD UNDER CONSTRUCTION" OR "ROAD WORK AHEAD" SIGNS IN LIEU OF STATIONARY ADVANCE WARNINGS SIGNS.

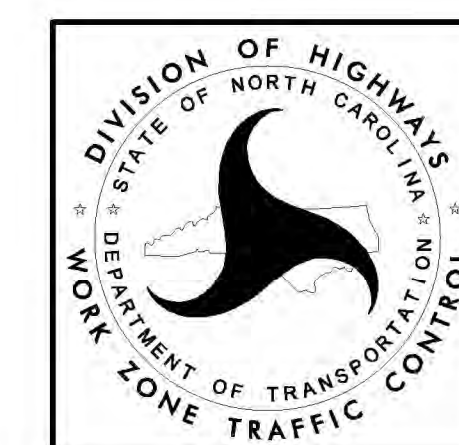

ADVANCE WARNING SIGNS FOR RURAL AND SUBURBAN 2-LANE ROADWAY RESURFACING

URBAN / SUBURBAN WORKZONES

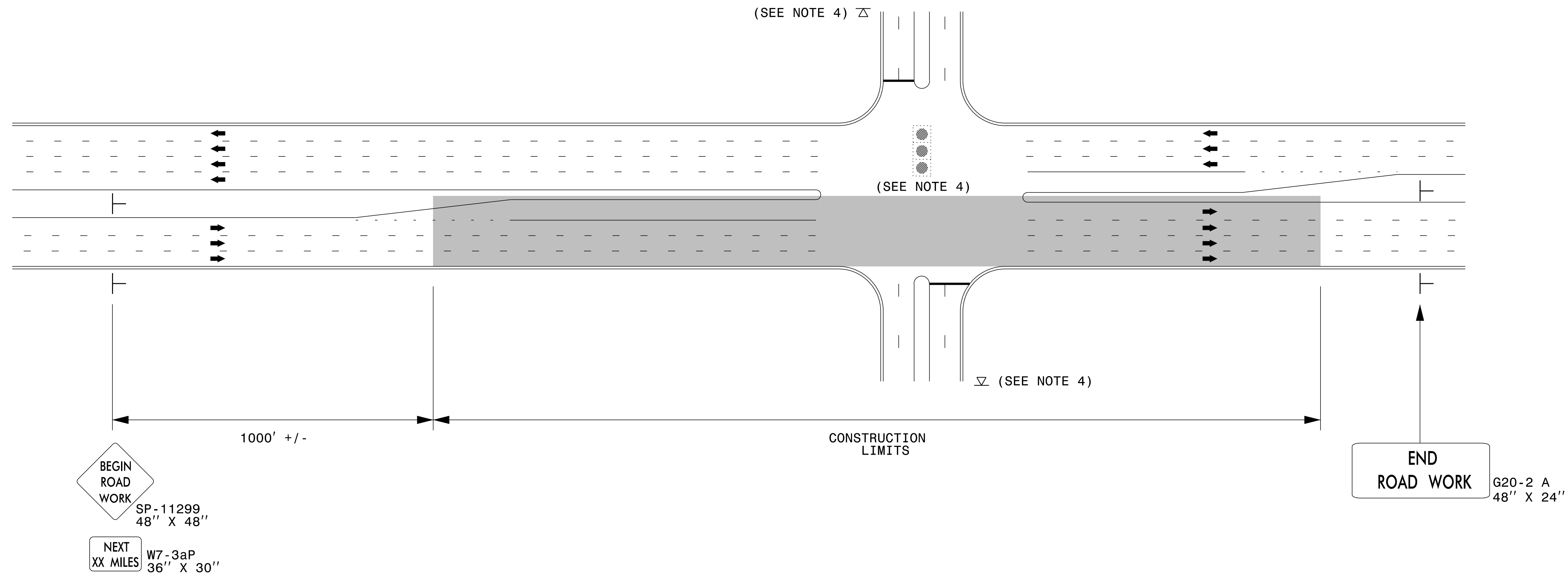

NOTES:

- 1) 48" x 48" SIZED SIGNS (SP- 11299) MAY BE REDUCED TO 36" X 36" ON ROADWAYS WITH SPEED LIMITS OF 40 MPH OR LESS.
- 2) MOUNT SIGNS THAT ARE LARGER THAN 10 SQUARE FEET IN AREA ON TWO OR MORE WOOD OR U-CHANNEL SUPPORTS. PERFORATED SQUARE TUBING SUPPORT SYSTEMS MAY SUPPORT LARGER AREAS ON A SINGLE SUPPORT. FOLLOW MANUFACTURER'S RECOMMENDATIONS. THESE SYSTEMS SHALL BE NCHRP 350 COMPLIANT AND NCDOT APPROVED.
- 3) ADVANCE WARNING SIGNS NOT REQUIRED ON NON-SIGNALIZED SIDE STREETS.
- 4) MAY USE LAW ENFORCEMENT TO CONTROL TRAFFIC AT SIGNALIZED INTERSECTIONS AS DIRECTED BY THE ENGINEER. PROVIDE PORTABLE "ROAD WORK AHEAD" (W20-1) SIGNS 500' IN ADVANCE ALONG BOTH APPROACHES FROM THE SIDE STREETS WHEN PAVING PROCEEDS THROUGH THE INTERSECTION.
- 5) LATERAL CLEARANCE AT ALL SIGN LOCATIONS SHALL BE 2' AS MEASURED FROM THE EDGE OF PAVEMENT OR THE FACE OF THE CURB. WHEN UNABLE TO OBTAIN THE LATERAL CLEARANCE WITHIN THE MEDIAN AREA USE SHOULDER MOUNTS ONLY.
- 6) SIGN MOUNT LOCATIONS SHALL NOT BLOCK SIDEWALKS OR DRIVEWAYS.
- 7) IF STATIONARY GENERAL WARNING SIGNS ARE USED, THEY WILL BE PAID FOR PER SECTION 104 OF THE NCDOT STANDARD SPECIFICATIONS AS EXTRA WORK.
- 8) IF MILLED AREAS ARE NOT PAVED BACK BY THE END OF THE WORK DAY, PORTABLE SIGNS SHALL BE USED TO WARN DRIVERS OF THE PRESENT CONDITIONS. THESE ARE TO INCLUDE, BUT NOT LIMITED TO "ROUGH ROAD" W8-8, "UNEVEN LANES" W8-11, "GROOVED PAVEMENT" W8-15 w/MOTORCYCLE PLAQUE MOUNTED BELOW. THESE ARE TO BE DOUBLE INDICATED ON MULTI-LANE ROADWAYS WITH SPEED LIMITS 45 MPH AND GREATER WHERE LATERAL CLEARANCE CAN BE OBTAINED WITHIN THE MEDIAN AREAS. THESE PORTABLE SIGNS ARE INCIDENTAL TO THE OTHER ITEMS OF WORK INCLUDED IN THE TEMPORARY TRAFFIC CONTROL (LUMP SUM) PAY ITEM.

LEGEND

- ├ STATIONARY SIGN
- ➔ DIRECTION OF TRAFFIC FLOW

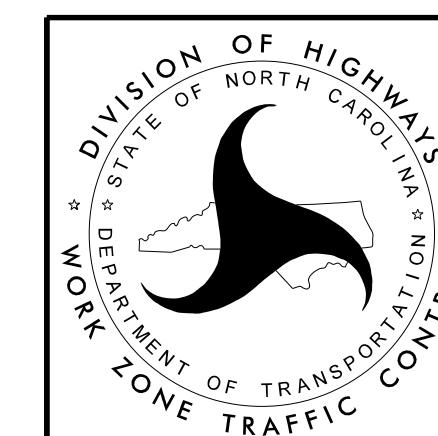

**RESURFACING ADVANCE
WARNING SIGNS FOR
URBAN / SUBURBAN
FACILITIES**

Traffic Control for Centerline and Edgeline Milled Rumble Strips

(11-25-2025)

In addition to the traffic control requirements found elsewhere in this Contract, the Contractor shall provide the following to maintain traffic during centerline and edgeline milled rumble strip operations:

1. Five (5) Flaggers, including three (3) flaggers to operate the pilot vehicles
2. Three (3) Pilot Vehicles
3. Eight (8) Portable Changeable Message Signs (PCMS)

Construction Methods

Work hours shall be 9am – 4pm Monday through Sunday, unless directed otherwise by the Engineer. Night work is prohibited.

Prior to setting up any traffic control devices, submit a layout drawing indicating PCMS locations for each map and operation to the Engineer for review and approval. Ensure placement of PCMS is outside of the open travel lane and delineate each PCMS with at least 3 traffic drums. Adjust mileage messages displayed on the PCMS to reflect actual distances based upon suitable locations.

Prior to beginning activity, install PCMS approximately 1 mile in advance of the active work area or at the next intersection if the roadway comes to an end and at 4 mile +/- increments in both directions. Display SLOW STOPPED TRAFFIC / NEXT XX MILES on the PCMS, or other similar messages as directed by the Engineer. Refer to attached drawing titled PCMS LAYOUT.

Use pilot vehicles equipped with sign G20-4 PILOT CAR FOLLOW ME installed at a conspicuous position on the rear of the vehicle. Rotate pilot vehicles continuously while operations are ongoing as detailed in the attached drawing titled TRAFFIC CONTROL FOR CENTERLINE AND MILLED RUMBLE STRIPS.

A minimum of two (2) flaggers, positioned at each work area approach, shall be utilized to assist with maintaining traffic. All pilot vehicle operations and flaggers shall have the ability to communicate by 2-way radio.

Measurement and Payment

Temporary traffic control work, including, but not limited to installation and removal of drums, flaggers, portable changeable message signs, and pilot vehicles for the sole purpose of maintaining vehicular traffic during centerline and edgeline rumble strip operations will be paid at the contract lump sum price for *Centerline and Edgeline Rumble Strip Temporary Traffic Control*. This will

include the work of five (5) flaggers. The operators of the pilot vehicles will be considered three of the five flaggers.

Any additional flagging beyond the included amount covered in the *Centerline and Edgeline Rumble Strip Temporary Traffic Control* pay item will be considered supplemental flagging and compensated at a rate of \$35.00 per hour for each additional flagger as approved by the Engineer. The minimum measurement for each additional flagger will be 4 hours, even if the actual additional flagger hours are less than 4 hours.

Payment will be made under:

Pay Item	Pay Unit
Centerline and Edgeline Rumble Strip Temporary Traffic Control	Lump Sum

TRAFFIC CONTROL FOR CENTERLINE AND EDGELINE MILLED RUMBLE STRIPS

NOTES:

1. MANAGE TRAFFIC BY USE OF PILOT VEHICLES CONTINUOUSLY ROTATING AS DETAILED IN THE BELOW SEQUENCE
2. WORK AREA NOT TO EXCEED 15 MILES DAILY
3. ALL PILOT VEHICLE OPERATORS AND FLAGGERS SHALL HAVE THE ABILITY TO COMMUNICATE BY 2-WAY RADIO

LEGEND

- M MILLING VEHICLE
- S SHADOW VEHICLE
- PV (#) PILOT VEHICLE (3 TOTAL)
- F (#) FLAGGER (2 MINIMUM)
- X VEHICLES
- DIRECTIONAL FLOW ARROW

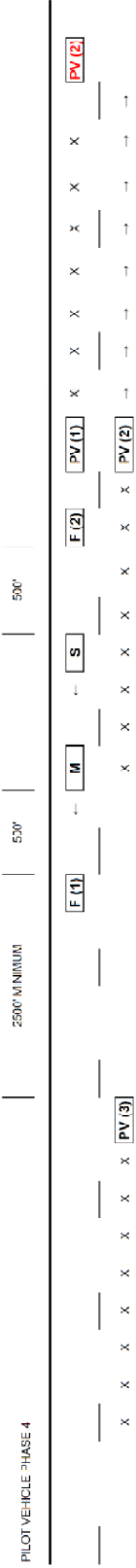
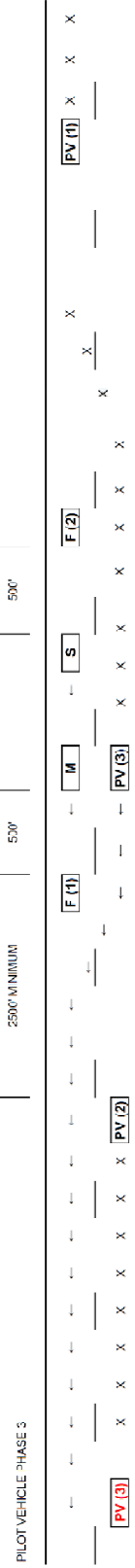
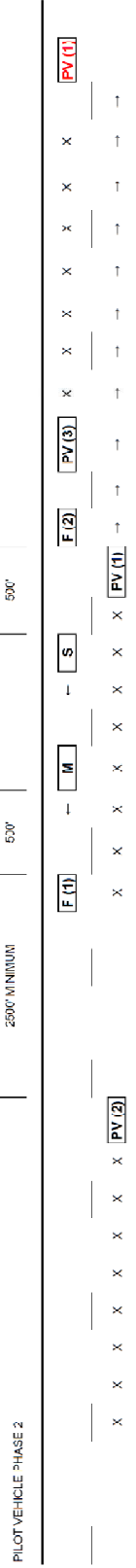
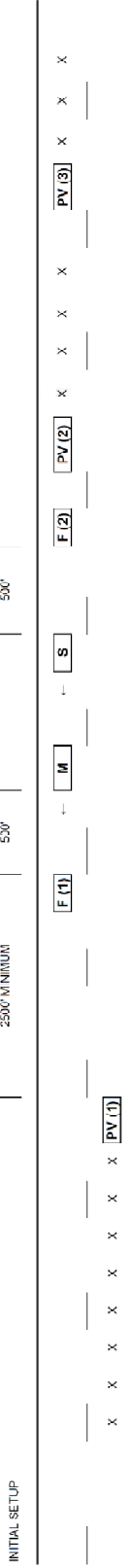

STANDARD SPECIAL PROVISION
AVAILABILITY OF FUNDS – TERMINATION OF CONTRACTS

(5-20-08)(Rev. 1-16-24)

Z-2

General Statute 143C-6-11. (h) Highway Appropriation is hereby incorporated verbatim in this contract as follows:

(h) Amounts Encumbered. – Transportation project appropriations may be encumbered in the amount of allotments made to the Department of Transportation by the Director for the estimated payments for transportation project contract work to be performed in the appropriation fiscal year. The allotments shall be multiyear allotments and shall be based on estimated revenues and shall be subject to the maximum contract authority contained in *General Statute 143C-6-11(c)*. Payment for transportation project work performed pursuant to contract in any fiscal year other than the current fiscal year is subject to appropriations by the General Assembly. Transportation project contracts shall contain a schedule of estimated completion progress, and any acceleration of this progress shall be subject to the approval of the Department of Transportation provided funds are available. The State reserves the right to terminate or suspend any transportation project contract, and any transportation project contract shall be so terminated or suspended if funds will not be available for payment of the work to be performed during that fiscal year pursuant to the contract. In the event of termination of any contract, the contractor shall be given a written notice of termination at least 60 days before completion of scheduled work for which funds are available. In the event of termination, the contractor shall be paid for the work already performed in accordance with the contract specifications.

Payment will be made on any contract terminated pursuant to the special provision in accordance with Subarticle 108-13(D) of the *Standard Specifications*.

STANDARD SPECIAL PROVISION
ERRATA

(1-16-24)(Rev. 1-20-26)

Z-4

Revise the *2024 Standard Specifications* as follows:

Division 1

Page 1-36, Subarticle 104-12(B) Evaluation of Proposals, line 21, replace "Design-Build Unit" with "Alternative Delivery Unit".

Page 1-36, Subarticle 104-12(D) Preliminary Review, line 37, replace "Design-Build Unit" with "Alternative Delivery Unit".

Page 1-37, Subarticle 104-12(E) Final Proposal, line 3, replace "Design-Build Unit" with "Alternative Delivery Unit".

Page 1-37, Subarticle 104-12(F) Design-Build VEPs, line 36, replace "Design-Build Unit" with "Alternative Delivery Unit".

Page 1-38, Subarticle 104-12(G) Modifications, line 1, replace "Design-Build Unit" with "Alternative Delivery Unit".

Division 3

Page 3-5, Article 305-2 MATERIALS, after line 16, replace " 1032-3(A)(7)" with "1032-3" and add the item "Galvanized Corrugated Steel Pipe" with Section "1032-3".

Page 3-6, Article 310-2 MATERIALS, after line 9, add the item "Galvanized Corrugated Steel Pipe" with Section "1032-3".

Division 6

Page 6-15, Article 610-1 DESCRIPTION, line 20, replace "The work includes" with "The work includes, but is not limited to,".

Page 6-15, Article 610-1 DESCRIPTION, line 22, replace "applying the tack coat as specified." with "applying the tack coat in accordance with Section 605.".

Page 6-30, Article 610-14 DENSITY ACCEPTANCE, line 39, replace "QC process." with "QC process in accordance with Section 609.".

Page 6-31, Article 610-16 MEASUREMENT AND PAYMENT, line 13, replace "*Hot Mix Asphalt Pavement*" with "*Asphalt Concrete _____ Course, Type _____*".

Page 6-50, Subarticle 661-4(A) Equipment, lines 4-7, replace the first two sentences of the seventh paragraph with the following:

When an erected fixed stringline is utilized for longitudinal profile and cross slope control furnish and erect the necessary guide line for the equipment.

Division 7

Page 7-18, Subarticle 710-10(A) General, lines 7-8, delete “for *Surface Testing Concrete Pavement*” from the last paragraph.

Division 8

Page 8-27, Article 846-1 DESCRIPTION, line 8, delete “4 inch” from the first paragraph.

Division 9

Page 9-17, Article 904-4 MEASUREMENT AND PAYMENT, prior to line 1, replace " Sign Erection, Relocate Type (Ground Mounted)" with “Sign Erection, Relocate Type ___ (Ground Mounted)”.

Division 10

Page 10-51, Article 1024-4 WATER, prior to line 1, delete the “unpopulated blank row” in Table 1024-2 between “Time of set, deviation from control” and “Chloride Ion Content, Max.”.

Page 10-170, Subarticle 1081-1(C) Requirements, line 4, replace "maximum" with “minimum”.

Division 11

Page 11-15, Article 1160-4 MEASUREMENT AND PAYMENT, line 24, replace “Where barrier units are moved more than one” with “Where barrier units are moved more than once”.

Division 15

Page 15-10, Article 1515-4 MEASUREMENT AND PAYMENT, lines 11, replace " All piping" with “All labor, the manhole, other materials, excavation, backfilling, piping”.

Division 16

Page 16-14, Article 1633-5 MEASUREMENT AND PAYMENT, line 20-24 and prior to line 25, delete and replace with the following " *Flocculant* will be measured and paid in accordance with Article 1642-5 applied to the temporary rock silt checks.”

Page 16-3, Article 1609-2 MATERIALS, after line 26, replace "Type 4" with “Type 4a”.

Page 16-25, Article 1644-2 MATERIALS, after line 22, replace "Type 4" with “Type 4a”.

Division 17

Page 17-15, Article 1715-4 MEASUREMENT AND PAYMENT, line 23, delete and replace “1.25” with “1-1/4”.

Page 17-15, Article 1715-4 MEASUREMENT AND PAYMENT, line 24, delete and replace “(1.25” with “, 1-1/4”.

STANDARD SPECIAL PROVISION**PLANT AND PEST QUARANTINES**

(Imported Fire Ant, Guava Root Knot Nematode, Spongy Moth (formerly known as gypsy moth), Witchweed, Cogon Grass, And Any Other Regulated Noxious Weed or Plant Pest)

(3-18-03)(Rev. 3-18-25)

Z-04a

Within Quarantined Area

This project may be within a county regulated for plant and/or pests. If the project or any part of the Contractor's operations is located within a quarantined area, thoroughly clean all equipment prior to moving out of the quarantined area. Comply with federal/state regulations by obtaining a certificate or limited permit for any regulated article moving from the quarantined area.

Originating in a Quarantined County

Obtain a certificate or limited permit issued by the N.C. Department of Agriculture/United States Department of Agriculture. Have the certificate or limited permit accompany the article when it arrives at the project site.

Contact

Contact the N.C. Department of Agriculture/United States Department of Agriculture at 1-800-206-9333, 919-707-3730, or <https://www.ncagr.gov/divisions/plant-industry/plant-protection/plant-industry-plant-pest-quarantines> to determine those specific project sites located in the quarantined area or for any regulated article used on this project originating in a quarantined county.

Regulated Articles Include

1. Soil, sand, gravel, compost, peat, humus, muck, and decomposed manure, separately or with other articles. This includes movement of articles listed above that may be associated with cut/waste, ditch pulling, and shoulder cutting.
2. Plants with roots including grass sod.
3. Plant crowns and roots.
4. Bulbs, corms, rhizomes, and tubers of ornamental plants.
5. Hay, straw, fodder, and plant litter of any kind.
6. Clearing and grubbing debris.
7. Used agricultural cultivating and harvesting equipment.
8. Used earth-moving equipment.
9. Any other products, articles, or means of conveyance of any character, if determined by an inspector present a hazard of spreading imported fire ant, guava root knot nematode, spongy moth (formerly known as gypsy moth), witchweed, cogon grass, or other regulated noxious weed or plant pest.

STANDARD SPECIAL PROVISION**MINIMUM WAGES**

(7-21-09)

Z-5

FEDERAL: The Fair Labor Standards Act provides that with certain exceptions every employer shall pay wages at the rate of not less than SEVEN DOLLARS AND TWENTY FIVE CENTS (\$7.25) per hour.

STATE: The North Carolina Minimum Wage Act provides that every employer shall pay to each of his employees, wages at a rate of not less than SEVEN DOLLARS AND TWENTY FIVE CENTS (\$7.25) per hour.

The minimum wage paid to all skilled labor employed on this contract shall be SEVEN DOLLARS AND TWENTY FIVE CENTS (\$7.25) per hour.

The minimum wage paid to all intermediate labor employed on this contract shall be SEVEN DOLLARS AND TWENTY FIVE CENTS (\$7.25) per hour.

The minimum wage paid to all unskilled labor on this contract shall be SEVEN DOLLARS AND TWENTY FIVE CENTS (\$7.25) per hour.

This determination of the intent of the application of this act to the contract on this project is the responsibility of the Contractor.

The Contractor shall have no claim against the Department of Transportation for any changes in the minimum wage laws, Federal or State. It is the responsibility of the Contractor to keep fully informed of all Federal and State Laws affecting his contract.

STANDARD SPECIAL PROVISION**TITLE VI AND NONDISCRIMINATION:**

(6-28-77)(Rev 1/16/2024)

Z-6

The North Carolina Department of Transportation is committed to carrying out the U.S. Department of Transportation's policy of ensuring nondiscrimination in the award and administration of contracts.

The provisions of this section related to United States Department of Transportation (US DOT) Order 1050.2A, Title 49 Code of Federal Regulations (CFR) part 21, 23 United States Code (U.S.C.) 140 and 23 CFR part 200 (or 49 CFR 303, 49 U.S.C. 5332 or 49 U.S.C. 47123) are applicable to all North Carolina Department of Transportation (NCDOT) contracts and to all related subcontracts, material supply, engineering, architectural and other service contracts, regardless of dollar amount. Any Federal provision that is specifically required not specifically set forth is hereby incorporated by reference.

(1) Title VI Assurances (USDOT Order 1050.2A, Appendix A)

During the performance of this contract, the contractor, for itself, its assignees, and successors in interest (hereinafter referred to as the "contractor") agrees as follows:

(a) Compliance with Regulations

The contractor (hereinafter includes consultants) shall comply with the Acts and the Regulations relative to Nondiscrimination in Federally-assisted programs of the U.S. Department of Transportation, Federal Highway Administration (FHWA), as they may be amended from time to time, which are herein incorporated by reference and made a part of this contract.

(b) Nondiscrimination

The contractor, with regard to the work performed by it during the contract, shall not discriminate on the grounds of race, color, or national origin in the selection and retention of subcontractors, including procurements of materials and leases of equipment. The contractor shall not participate directly or indirectly in the discrimination prohibited by the Acts and the Regulations, including employment practices when the contract covers any activity, project, or program set forth in Appendix B of 49 CFR Part 21.

(c) Solicitations for Subcontractors, Including Procurements of Materials and Equipment

In all solicitations, either by competitive bidding, or negotiation made by the contractor for work to be performed under a subcontract, including procurements of materials, or leases of equipment, each potential subcontractor or supplier shall be notified by the contractor of the contractor's obligations under this contract and the Acts and the Regulations relative to Nondiscrimination on the grounds of race, color, or national origin.

(d) Information and Reports

The contractor shall provide all information and reports required by the Acts, the Regulations, and directives issued pursuant thereto and shall permit access to its

books, records, accounts, other sources of information, and its facilities as may be determined by the Recipient or the FHWA to be pertinent to ascertain compliance with such Acts, Regulations, and instructions. Where any information required of a contractor is in the exclusive possession of another who fails or refuses to furnish the information, the contractor shall so certify to the Recipient or the FHWA, as appropriate, and shall set forth what efforts it has made to obtain the information.

(e) Sanctions for Noncompliance:

In the event of a contractor's noncompliance with the Non-discrimination provisions of this contract, the Recipient will impose such contract sanctions as it and/or the FHWA may determine to be appropriate, including, but not limited to:

- (i) Withholding payments to the contractor under the contract until the contractor complies; and/or
- (ii) Cancelling, terminating, or suspending a contract, in whole or in part.

(f) Incorporation of Provisions

The contractor shall include the provisions of paragraphs (a) through (f) in every subcontract, including procurements of materials and leases of equipment, unless exempt by the Acts, the Regulations and directives issued pursuant thereto. The contractor shall take action with respect to any subcontract or procurement as the Recipient or the FHWA may direct as a means of enforcing such provisions including sanctions for noncompliance. Provided, that if the contractor becomes involved in, or is threatened with litigation by a subcontractor, or supplier because of such direction, the contractor may request the Recipient to enter into any litigation to protect the interests of the Recipient. In addition, the contractor may request the United States to enter into the litigation to protect the interests of the United States.

(2) Title VI Nondiscrimination Program (23 CFR 200.5(p))

The North Carolina Department of Transportation (NCDOT) has assured the USDOT that, as a condition to receiving federal financial assistance, NCDOT will comply with Title VI of the Civil Rights Act of 1964 and all requirements imposed by Title 49 CFR part 21 and related nondiscrimination authorities to ensure that no person shall, on the ground of race, color, national origin, limited English proficiency, sex, age, or disability (including religion/creed or income-level, where applicable), be excluded from participation in, be denied the benefits of, or be subjected to discrimination under any programs, activities, or services conducted or funded by NCDOT. Contractors and other organizations under contract or agreement with NCDOT must also comply with Title VI and related authorities, therefore:

- (a) During the performance of this contract or agreement, contractors (e.g., subcontractors, consultants, vendors, prime contractors) are responsible for complying with NCDOT's Title VI Program. Contractors are not required to prepare or submit Title VI Programs. To comply with this section, the prime contractor shall:
 1. Post NCDOT's Notice of Nondiscrimination and the Contractor's own Equal Employment Opportunity (EEO) Policy in conspicuous locations accessible to all employees, applicants and subcontractors on the jobsite.

2. Physically incorporate the required Title VI clauses into all subcontracts on federally-assisted and state-funded NCDOT projects, and ensure inclusion by subcontractors into all lower-tier subcontracts.
 3. Required Solicitation Language. The Contractor shall include the following notification in all solicitations for bids and requests for work or material, regardless of funding source:

“The North Carolina Department of Transportation, in accordance with the provisions of Title VI of the Civil Rights Act of 1964 (78 Stat. 252, 42 U.S.C. §§ 2000d to 2000d-4) and the Regulations, hereby notifies all bidders that it will affirmatively ensure that any contract entered into pursuant to this advertisement, disadvantaged business enterprises will be afforded full and fair opportunity to submit bids in response to this invitation and will not be discriminated against on the grounds of race, color, or national origin in consideration for an award. In accordance with other related nondiscrimination authorities, bidders and contractors will also not be discriminated against on the grounds of sex, age, disability, low-income level, creed/religion, or limited English proficiency in consideration for an award.”
 4. Physically incorporate the FHWA-1273, in its entirety, into all subcontracts and subsequent lower tier subcontracts on Federal-aid highway construction contracts only.
 5. Provide language assistance services (i.e., written translation and oral interpretation), free of charge, to LEP employees and applicants. Contact NCDOT OCR for further assistance, if needed.
 6. For assistance with these Title VI requirements, contact the NCDOT Title VI Nondiscrimination Program at 1-800-522-0453.
- (b) Subrecipients (e.g. cities, counties, LGAs, planning organizations) may be required to prepare and submit a Title VI Plan to NCDOT, including Title VI Assurances and/or agreements. Subrecipients must also ensure compliance by their contractors and subrecipients with Title VI. (23 CFR 200.9(b)(7))
 - (c) If reviewed or investigated by NCDOT, the contractor or subrecipient agrees to take affirmative action to correct any deficiencies found within a reasonable time period, not to exceed 90 calendar days, unless additional time is granted by NCDOT. (23 CFR 200.9(b)(15))
 - (d) The Contractor is responsible for notifying subcontractors of NCDOT’s External Discrimination Complaints Process.
 1. Applicability

Title VI and related laws protect participants and beneficiaries (e.g., members of the public and contractors) from discrimination by NCDOT employees, subrecipients and contractors, regardless of funding source.

2. Eligibility

Any person—or class of persons—who believes he/she has been subjected to discrimination based on race, color, national origin, Limited English Proficiency (LEP), sex, age, or disability (and religion in the context of employment, aviation, or transit) may file a written complaint. The law also prohibits intimidation or retaliation of any sort.

3. Time Limits and Filing Options

Complaints may be filed by the affected individual(s) or a representative and must be filed no later than 180 calendar days after the following:

- (i) The date of the alleged act of discrimination; or
- (ii) The date when the person(s) became aware of the alleged discrimination; or
- (iii) Where there has been a continuing course of conduct, the date on which that conduct was discontinued or the latest instance of the conduct.

Title VI and related discrimination complaints may be submitted to the following entities:

- North Carolina Department of Transportation, Office of Civil Rights, Title VI Program, 1511 Mail Service Center, Raleigh, NC 27699-1511; toll free 1-800-522-0453
- Federal Highway Administration, North Carolina Division Office, 310 New Bern Avenue, Suite 410, Raleigh, NC 27601, 919-747-7010
- US Department of Transportation, Departmental Office of Civil Rights, External Civil Rights Programs Division, 1200 New Jersey Avenue, SE, Washington, DC 20590; 202-366-4070

4. Format for Complaints

Complaints must be in writing and signed by the complainant(s) or a representative, and include the complainant's name, address, and telephone number. Complaints received by fax or e-mail will be acknowledged and processed. Allegations received by telephone will be reduced to writing and provided to the complainant for confirmation or revision before processing. Complaints will be accepted in other languages, including Braille.

5. Discrimination Complaint Form

Contact NCDOT Civil Rights to receive a full copy of the Discrimination Complaint Form and procedures.

6. Complaint Basis

Allegations must be based on issues involving race, color, national origin (LEP), sex, age, disability, or religion (in the context of employment, aviation or transit). "Basis" refers to the complainant's membership in a protected group category.

TABLE 103-1 COMPLAINT BASIS			
Protected Categories	Definition	Examples	Applicable Nondiscrimination Authorities
Race and Ethnicity	An individual belonging to one of the accepted racial groups; or the perception, based usually on physical characteristics that a person is a member of a racial group	Black/African American, Hispanic/Latino, Asian, American Indian/Alaska Native, Native Hawaiian/Pacific Islander, White	Title VI of the Civil Rights Act of 1964; 49 CFR Part 21; 23 CFR 200; 49 U.S.C. 5332(b); 49 U.S.C. 47123. (<i>Executive Order 13166</i>)
Color	Color of skin, including shade of skin within a racial group	Black, White, brown, yellow, etc.	
National Origin (<i>Limited English Proficiency</i>)	Place of birth. Citizenship is not a factor. (<i>Discrimination based on language or a person's accent is also covered</i>)	Mexican, Cuban, Japanese, Vietnamese, Chinese	
Sex	Gender. The sex of an individual. <i>Note: Sex under this program does not include sexual orientation.</i>	Women and Men	1973 Federal-Aid Highway Act; 49 U.S.C. 5332(b); 49 U.S.C. 47123.
Age	Persons of any age	21-year-old person	Age Discrimination Act of 1975 49 U.S.C. 5332(b); 49 U.S.C. 47123.
Disability	Physical or mental impairment, permanent or temporary, or perceived.	Blind, alcoholic, para-amputee, epileptic, diabetic, arthritic	Section 504 of the Rehabilitation Act of 1973; Americans with Disabilities Act of 1990
Religion (in the context of employment) (<i>Religion/ Creed in all aspects of any aviation or transit-related construction</i>)	An individual belonging to a religious group; or the perception, based on distinguishable characteristics that a person is a member of a religious group. In practice, actions taken as a result of the moral and ethical beliefs as to what is right and wrong, which are sincerely held with the strength of traditional religious views. <i>Note: Does not have to be associated with a recognized religious group or church; if an individual sincerely holds to the belief, it is a protected religious practice.</i>	Muslim, Christian, Sikh, Hindu, etc.	Title VII of the Civil Rights Act of 1964; 23 CFR 230; FHWA-1273 Required Contract Provisions. (<i>49 U.S.C. 5332(b); 49 U.S.C. 47123</i>)

(3) Pertinent Nondiscrimination Authorities

During the performance of this contract, the contractor, for itself, its assignees, and successors in interest agrees to comply with the following non-discrimination statutes and authorities, including, but not limited to:

- (a) Title VI of the Civil Rights Act of 1964 (42 U.S.C. § 2000d et seq., 78 stat. 252), (prohibits discrimination on the basis of race, color, national origin); and 49 CFR Part 21.

- (b) The Uniform Relocation Assistance and Real Property Acquisition Policies Act of 1970, (42 U.S.C. § 4601), (prohibits unfair treatment of persons displaced or whose property has been acquired because of Federal or Federal-aid programs and projects);
- (c) Federal-Aid Highway Act of 1973, (23 U.S.C. § 324 et seq.), (prohibits discrimination on the basis of sex);
- (d) Section 504 of the Rehabilitation Act of 1973, (29 U.S.C. § 794 et seq.), as amended, (prohibits discrimination on the basis of disability) and 49 CFR Part 27;
- (e) The Age Discrimination Act of 1975, as amended, (42 U.S.C. § 6101 et seq.), (prohibits discrimination on the basis of age);
- (f) Airport and Airway Improvement Act of 1982, (49 USC § 471, Section 47123), as amended, (prohibits discrimination based on race, creed, color, national origin, or sex);
- (g) The Civil Rights Restoration Act of 1987, (PL 100-209), (Broadened the scope, coverage and applicability of Title VI of the Civil Rights Act of 1964, The Age Discrimination Act of 1975 and Section 504 of the Rehabilitation Act of 1973, by expanding the definition of the terms "programs or activities" to include all of the programs or activities of the Federal-aid recipients, sub-recipients and contractors, whether such programs or activities are Federally funded or not);
- (h) Titles II and III of the Americans with Disabilities Act, which prohibit discrimination on the basis of disability in the operation of public entities, public and private transportation systems, places of public accommodation, and certain testing entities (42 U.S.C. §§ 12131-12189) as implemented by Department of Transportation regulations at 49 C.F.R. parts 37 and 38;
- (i) The Federal Aviation Administration's Nondiscrimination statute (49 U.S.C. § 47123) (prohibits discrimination on the basis of race, color, national origin, and sex);
- (j) Executive Order 12898, Federal Actions to Address Environmental Justice in Minority Populations and Low-Income Populations, which ensures Nondiscrimination against minority populations by discouraging programs, policies, and activities with disproportionately high and adverse human health or environmental effects on minority and low-income populations;
- (k) Executive Order 13166, Improving Access to Services for Persons with Limited English Proficiency, and resulting agency guidance, national origin discrimination includes discrimination because of Limited English proficiency (LEP). To ensure compliance with Title VI, you must take reasonable steps to ensure that LEP persons have meaningful access to your programs (70 Fed. Reg. at 74087 to 74100);
- (l) Title IX of the Education Amendments of 1972, as amended, which prohibits you from discriminating because of sex in education programs or activities (20 U.S.C. 1681 et seq).
- (m) Title VII of the Civil Rights Act of 1964 (42 U.S.C. § 2000e et seq., Pub. L. 88-352), (prohibits employment discrimination on the basis of race, color, religion, sex, or national origin).

(4) Additional Title VI Assurances

***The following Title VI Assurances (Appendices B, C and D) shall apply, as applicable*

- (a) Clauses for Deeds Transferring United States Property (1050.2A, Appendix B)

The following clauses will be included in deeds effecting or recording the transfer of real property, structures, or improvements thereon, or granting interest therein from the United States pursuant to the provisions of Assurance 4.

NOW, THEREFORE, the U.S. Department of Transportation as authorized by law and upon the condition that the North Carolina Department of Transportation (NCDOT) will accept title to the lands and maintain the project constructed thereon in accordance with the North Carolina General Assembly, the Regulations for the Administration of the Federal-Aid Highway Program, and the policies and procedures prescribed by the Federal Highway Administration of the U.S. Department of Transportation in accordance and in compliance with all requirements imposed by Title 49, Code of Federal Regulations, U.S. Department of Transportation, Subtitle A, Office of the Secretary, Part 21, Nondiscrimination in Federally-assisted programs of the U.S. Department of Transportation pertaining to and effectuating the provisions of Title VI of the Civil Rights Act of 1964 (78 Stat. 252; 42 U.S.C. § 2000d to 2000d-4), does hereby remise, release, quitclaim and convey unto the NCDOT all the right, title and interest of the U.S. Department of Transportation in and to said lands described in Exhibit A attached hereto and made a part hereof.

(HABENDUM CLAUSE)

TO HAVE AND TO HOLD said lands and interests therein unto the North Carolina Department of Transportation (NCDOT) and its successors forever, subject, however, to the covenants, conditions, restrictions and reservations herein contained as follows, which will remain in effect for the period during which the real property or structures are used for a purpose for which Federal financial assistance is extended or for another purpose involving the provision of similar services or benefits and will be binding on the NCDOT, its successors and assigns.

The NCDOT, in consideration of the conveyance of said lands and interests in lands, does hereby covenant and agree as a covenant running with the land for itself, its successors and assigns, that (1) no person will on the grounds of race, color, or national origin, be excluded from participation in, be denied the benefits of, or be otherwise subjected to discrimination with regard to any facility located wholly or in part on, over, or under such lands hereby conveyed [,] [and]* (2) that the NCDOT will use the lands and interests in lands and interests in lands so conveyed, in compliance with all requirements imposed by or pursuant to Title 49, Code of Federal Regulations, U.S. Department of Transportation, Subtitle A, Office of the Secretary, Part 21, Non-discrimination in Federally-assisted programs of the U.S. Department of Transportation, Effectuation of Title VI of the Civil Rights Act of 1964, and as said Regulations and Acts may be amended [, and (3) that in the event of breach of any of the above-mentioned nondiscrimination conditions, the Department will have a right to enter or re-enter said lands and facilities on said land, and that above described land and facilities will thereon revert to and vest in and become the absolute property of the U.S. Department of Transportation and its assigns as such interest existed prior to this instruction].*

(*Reverter clause and related language to be used only when it is determined that such a clause is necessary in order to make clear the purpose of Title VI.)

(b) Clauses for Transfer of Real Property Acquired or Improved Under the Activity, Facility, or Program (1050.2A, Appendix C)

The following clauses will be included in deeds, licenses, leases, permits, or similar instruments entered into by the North Carolina Department of Transportation (NCDOT) pursuant to the provisions of Assurance 7(a):

1. The (grantee, lessee, permittee, etc. as appropriate) for himself/herself, his/her heirs, personal representatives, successors in interest, and assigns, as a part of the consideration hereof, does hereby covenant and agree [in the case of deeds and leases add "as a covenant running with the land"] that:
 - (i.) In the event facilities are constructed, maintained, or otherwise operated on the property described in this (deed, license, lease, permit, etc.) for a purpose for which a U.S. Department of Transportation activity, facility, or program is extended or for another purpose involving the provision of similar services or benefits, the (grantee, licensee, lessee, permittee, etc.) will maintain and operate such facilities and services in compliance with all requirements imposed by the Acts and Regulations (as may be amended) such that no person on the grounds of race, color, or national origin, will be excluded from participation in, denied the benefits of, or be otherwise subjected to discrimination in the use of said facilities.
2. With respect to licenses, leases, permits, etc., in the event of breach of any of the above Nondiscrimination covenants, the NCDOT will have the right to terminate the (lease, license, permit, etc.) and to enter, re-enter, and repossess said lands and facilities thereon, and hold the same as if the (lease, license, permit, etc.) had never been made or issued. *
3. With respect to a deed, in the event of breach of any of the above Nondiscrimination covenants, the NCDOT will have the right to enter or re-enter the lands and facilities thereon, and the above described lands and facilities will there upon revert to and vest in and become the absolute property of the NCDOT and its assigns. *

(*Reverter clause and related language to be used only when it is determined that such a clause is necessary to make clear the purpose of Title VI.)

(c) Clauses for Construction/Use/Access to Real Property Acquired Under the Activity, Facility or Program (1050.2A, Appendix D)

The following clauses will be included in deeds, licenses, permits, or similar instruments/ agreements entered into by the North Carolina Department of Transportation (NCDOT) pursuant to the provisions of Assurance 7(b):

1. The (grantee, licensee, permittee, etc., as appropriate) for himself/herself, his/her heirs, personal representatives, successors in interest, and assigns, as a part of the consideration hereof, does hereby covenant and agree (in the case of deeds and leases add, "as a covenant running with the land") that (1) no person on the ground of race, color, or national origin, will be excluded from participation in, denied the benefits of, or be otherwise subjected to discrimination in the use of said facilities, (2) that in the construction of any improvements on, over, or under such land, and the furnishing of services thereon, no person on the ground of race, color, or national origin, will be excluded from participation in, denied the benefits of, or otherwise be subjected to discrimination, (3) that the (grantee, licensee, lessee, permittee, etc.) will use the premises in compliance with all other requirements imposed by or pursuant to the Acts and Regulations, as amended, set forth in this Assurance.
2. With respect to (licenses, leases, permits, etc.), in the event of breach of any of the above Non-discrimination covenants, the NCDOT will have the right to terminate the (license, permit, etc., as appropriate) and to enter or re-enter and repossess said land and the facilities thereon, and hold the same as if said (license, permit, etc., as appropriate) had never been made or issued. *
3. With respect to deeds, in the event of breach of any of the above Nondiscrimination covenants, the NCDOT will there upon revert to and vest in and become the absolute property of the NCDOT and its assigns. *

(*Reverter clause and related language to be used only when it is determined that such a clause is necessary to make clear the purpose of Title VI.)

STANDARD SPECIAL PROVISION**ON-THE-JOB TRAINING**

(10-16-07) (Rev. 4-21-15)

Z-10

Description

The North Carolina Department of Transportation will administer a custom version of the Federal On-the-Job Training (OJT) Program, commonly referred to as the Alternate OJT Program. All contractors (existing and newcomers) will be automatically placed in the Alternate Program. Standard OJT requirements typically associated with individual projects will no longer be applied at the project level. Instead, these requirements will be applicable on an annual basis for each contractor administered by the OJT Program Manager.

On the Job Training shall meet the requirements of 23 CFR 230.107 (b), 23 USC – Section 140, this provision and the On-the-Job Training Program Manual.

The Alternate OJT Program will allow a contractor to train employees on Federal, State and privately funded projects located in North Carolina. However, priority shall be given to training employees on NCDOT Federal-Aid funded projects.

Minorities and Women

Developing, training and upgrading of minorities and women toward journeyman level status is a primary objective of this special training provision. Accordingly, the Contractor shall make every effort to enroll minority and women as trainees to the extent that such persons are available within a reasonable area of recruitment. This training commitment is not intended, and shall not be used, to discriminate against any applicant for training, whether a member of a minority group or not.

Assigning Training Goals

The Department, through the OJT Program Manager, will assign training goals for a calendar year based on the contractors' past three years' activity and the contractors' anticipated upcoming year's activity with the Department. At the beginning of each year, all contractors eligible will be contacted by the Department to determine the number of trainees that will be assigned for the upcoming calendar year. At that time the Contractor shall enter into an agreement with the Department to provide a self-imposed on-the-job training program for the calendar year. This agreement will include a specific number of annual training goals agreed to by both parties. The number of training assignments may range from 1 to 15 per contractor per calendar year. The Contractor shall sign an agreement to fulfill their annual goal for the year.\

Training Classifications

The Contractor shall provide on-the-job training aimed at developing full journeyman level workers in the construction craft/operator positions. Preference shall be given to providing training in the following skilled work classifications:

Equipment Operators	Office Engineers
Truck Drivers	Estimators
Carpenters	Iron / Reinforcing Steel Workers
Concrete Finishers	Mechanics
Pipe Layers	Welders

The Department has established common training classifications and their respective training requirements that may be used by the contractors. However, the classifications established are not all-inclusive. Where the training is oriented toward construction applications, training will be allowed in lower-level management positions such as office engineers and estimators. Contractors shall submit new classifications for specific job functions that their employees are performing. The Department will review and recommend for acceptance to FHWA the new classifications proposed by contractors, if applicable. New classifications shall meet the following requirements:

Proposed training classifications are reasonable and realistic based on the job skill classification needs, and

The number of training hours specified in the training classification is consistent with common practices and provides enough time for the trainee to obtain journeyman level status.

The Contractor may allow trainees to be trained by a subcontractor provided that the Contractor retains primary responsibility for meeting the training and this provision is made applicable to the subcontract. However, only the Contractor will receive credit towards the annual goal for the trainee.

Where feasible, 25 percent of apprentices or trainees in each occupation shall be in their first year of apprenticeship or training. The number of trainees shall be distributed among the work classifications on the basis of the contractor's needs and the availability of journeymen in the various classifications within a reasonable area of recruitment.

No employee shall be employed as a trainee in any classification in which they have successfully completed a training course leading to journeyman level status or in which they have been employed as a journeyman.

Records and Reports

The Contractor shall maintain enrollment, monthly and completion reports documenting company compliance under these contract documents. These documents and any other information as requested shall be submitted to the OJT Program Manager.

Upon completion and graduation of the program, the Contractor shall provide each trainee with a certification Certificate showing the type and length of training satisfactorily completed.

Trainee Interviews

All trainees enrolled in the program will receive an initial and Trainee/Post graduate interview conducted by the OJT program staff.

Trainee Wages

Contractors shall compensate trainees on a graduating pay scale based upon a percentage of the prevailing minimum journeyman wages (Davis-Bacon Act). Minimum pay shall be as follows:

60 percent	of the journeyman wage for the first half of the training period
75 percent	of the journeyman wage for the third quarter of the training period
90 percent	of the journeyman wage for the last quarter of the training period

In no instance shall a trainee be paid less than the local minimum wage. The Contractor shall adhere to the minimum hourly wage rate that will satisfy both the NC Department of Labor (NCDOL) and the Department.

Achieving or Failing to Meet Training Goals

The Contractor will be credited for each trainee employed by him on the contract work who is currently enrolled or becomes enrolled in an approved program and who receives training for at least 50 percent of the specific program requirement. Trainees will be allowed to be transferred between projects if required by the Contractor's scheduled workload to meet training goals.

If a contractor fails to attain their training assignments for the calendar year, they may be taken off the NCDOT's Bidders List.

Measurement and Payment

No compensation will be made for providing required training in accordance with these contract documents.

LISTING OF MBE/WBE SUBCONTRACTORS

			Sheet	of	
Firm Name and Address	Circle One	Item No.	Item Description	* Agreed upon Unit Price	** Dollar Volume of Item
Name	MBE				
Address	WBE				
Name	MBE				
Address	WBE				
Name	MBE				
Address	WBE				
Name	MBE				
Address	WBE				
Name	MBE				
Address	WBE				
Name	MBE				
Address	WBE				

* The Dollar Volume shown in this column shall be the Actual Price Agreed Upon by the Prime Contractor and the MBE/WBE subcontractor, and these prices will be used to determine the percentage of the MBE/WBE participation in the contract.

** Dollar Volume of MBE/WBE Subcontractor Percentage of Total Contract Bid Price:

If firm is a Material Supplier Only, show Dollar Volume as 60% of Agreed Upon Amount from Letter of Intent.

If firm is a Manufacturer, show Dollar Volume as 100% of Agreed Upon Amount from Letter of Intent.

LISTING OF MBE/WBE SUBCONTRACTORS

Sheet _____ of _____

Firm Name and Address	Circle One	Item No.	Item Description	* Agreed upon Unit Price	** Dollar Volume of Item
Name Address	MBE WBE				
Name Address	MBE WBE				
Name Address	MBE WBE				
Name Address	MBE WBE				
Name Address	MBE WBE				

**** Dollar Volume of MBE Subcontractor \$ _____**

MBE Percentage of Total Contract Bid Price _____%

**** Dollar Volume of WBE Subcontractor \$ _____**

WBE Percentage of Total Contract Bid Price _____%

***The Dollar Volume shown in this column shall be the Actual Price Agreed Upon by the Prime Contractor and the MBE/WBE subcontractor, and these prices will be used to determine the percentage of the MBE/WBE participation in the contract.**

**** Dollar Volume of MBE/WBE Subcontractor Percentage of Total Contract Bid Price.**

If firm is a Material Supplier Only, show Dollar Volume as 60% of Agreed Upon Amount from Letter of Intent.

If firm is a Manufacturer, show Dollar Volume as 100% of Agreed Upon Amount from Letter of Intent.

County: WILSON

Line #	Item Number	Sec #	Description	Quantity	Unit Cost	Amount
ROADWAY ITEMS						
0001	0000100000-N	800	MOBILIZATION	Lump Sum	L.S.	
0002	1220000000-E	545	INCIDENTAL STONE BASE	102 TON		
0003	1297000000-E	607	MILLING ASPHALT PAVEMENT, **** DEPTH 1-1/2"	200,887 SY		
0004	1330000000-E	607	INCIDENTAL MILLING	9,985 SY		
0005	1523000000-E	610	ASPHALT CONC SURFACE COURSE, TYPE S9.5C	17,607 TON		
0006	1575000000-E	620	ASPHALT BINDER FOR PLANT MIX	1,075 TON		
0007	1704000000-E	SP	PATCHING EXISTING PAVEMENT	750 TON		
0008	1881000000-E	SP	GENERIC PAVING ITEM 18" CENTERLINE SINUSOIDAL MILLED RUMBLE STRIPS	69,537 LF		
0009	1881000000-E	SP	GENERIC PAVING ITEM 8" EDGELINE SINUSOIDAL MILLED RUMBLE STRIPS	139,075 LF		
0010	4413000000-E	SP	WORK ZONE ADVANCE/GENERAL WARNING SIGNING	1,480 SF		
0011	4457000000-N	SP	TEMPORARY TRAFFIC CONTROL	Lump Sum	L.S.	
0012	4589000000-N	SP	GENERIC TRAFFIC CONTROL ITEM CENTERLINE & EDGELINE RUMBLE STRIP TEMPORARY TRAFFIC CONTROL	Lump Sum	L.S.	
0013	4688000000-E	1205	THERMOPLASTIC PAVEMENT MARKING LINES (6", 90 MILS)	271,196 LF		
0014	4695000000-E	1205	THERMOPLASTIC PAVEMENT MARKING LINES (8", 90 MILS)	1,400 LF		
0015	4700000000-E	1205	THERMOPLASTIC PAVEMENT MARKING LINES (12", 90 MILS)	500 LF		
0016	4704000000-E	1205	THERMOPLASTIC PAVEMENT MARKING LINES (16", 90 MILS)	60 LF		

County: WILSON

Line #	Item Number	Sec #	Description	Quantity	Unit Cost	Amount
0017	4709000000-E	1205	THERMOPLASTIC PAVEMENT MARKING LINES (24", 90 MILS)	100 LF		
0018	4720000000-E	1205	THERMOPLASTIC PAVEMENT MARKING CHARACTER (90 MILS)	8 EA		
0019	4815000000-E	1205	PAINT PAVEMENT MARKING LINES (6")	271,196 LF		
0020	4890000000-E	SP	GENERIC PAVEMENT MARKING ITEM INTERGRATED MULTIPOLYMER (IM) PAVEMENT MARKING	800 LF		
0021	4905100000-N	1253	NON-CAST IRON SNOWPLOWABLE PAVEMENT MARKER	870 EA		

0828/Jan06/Q986631/D68696200000/E21

Total Amount Of Bid For Entire Project :

Execution of Contract

Contract No: DD00503

County: WILSON COUNTY

ACCEPTED BY THE DEPARTMENT

DIVISION CONTRACT ENGINEER

Date

EXECUTION OF CONTRACT AND BONDS
APPROVED AS TO FORM:

for DIVISION ENGINEER

Date